



VIVAX
METROTECH

vLoc Series 2 User Handbook (vLocPro2, vLocML2+)

(English Edition)

Version 2.1

P/N: 4.04.000021



Table of Content

- 1. General Safety & Care Information.....1
 - 1.1 Who Can Use This Equipment.....1
 - 1.2 Work-site Safety.....1
 - 1.3 Equipment Safety.....1
 - 1.4 Batteries and Environmental Safety.....1
 - 1.4.1 Alkaline Batteries (Non Rechargeable).....1
 - 1.4.2 Nickel Metal Hydride Batteries (Rechargeable).....1
 - 1.4.3 Lithium-Ion Batteries (Rechargeable).....2
 - 1.4.4 Lithium Metal Batteries (Non Rechargeable).....2
 - 1.4.5 General Rules regarding Disposal of Batteries.....2
 - 1.4.6 Transportation of Lithium-Ion and Lithium-Metal Batteries.....2
 - 1.5 Care of Equipment.....2
 - 1.6 Care when Interpreting the Information provided by the Locator.....3
 - 1.7 American & Canadian Safety Notices.....3
- 2. Service & Support.....4
 - 2.1 Serial Number and Software Revision Number.....4
 - 2.2 Distributors and Service Centers Closest to You:.....5
- 3. vLocPro2 Receiver.....6
 - 3.1 vLocPro2 Receiver.....6
 - 3.2 Charging the Receiver Batteries.....6
 - 3.3 vLocPro2 Receiver Main Display.....7
 - 3.4 vLocPro2 Receiver Screen Shots.....8
 - 3.5 Locating Mode (Response).....9
 - 3.5.1 Peak Response Mode.....9
 - 3.5.2 Broad Peak Mode.....9
 - 3.5.3 Null Mode.....9
 - 3.5.4 Peak with Arrows Response Mode.....10
 - 3.5.5 Sonde Mode.....10
 - 3.6 Audio.....11
 - 3.7 Sensitivity Control.....11
 - 3.8 Frequency Selection.....11
 - 3.9 Information Pushbutton (Depth & Current).....12
 - 3.10 Information Pushbutton (Setup Menu).....13
- 4. vLocML2+ Receiver.....14
 - 4.1 Introduction.....14
 - 4.2 Operating the vLocML2+.....15
 - 4.2.1 Switching Between Configuration.....15
 - 4.2.2 Standard.....15
 - 4.2.3 Dedicated.....15
 - 4.2.4 Marker Depth Estimation in Dedicated Mode.....16



4.2.5	Dual Configuration.....	17
5.	Data Logging.....	19
5.1	Bluetooth.....	19
5.1.1	Fitting the Bluetooth Module.....	19
5.2	External GPS Device Overview.....	20
5.2.1	Pairing with the vLocPro2/vLocML2+ Receivers.....	20
5.2.2	Gathering Data in Active Modes.....	20
5.2.3	Gathering Data in Power and Radio (Passive) Modes.....	21
5.2.4	Transferring Data from the Locator to a Computer.....	21
5.3	Transferring Data from the vLoc2 to a Computer.....	21
5.3.1	MyLocator2.....	21
5.3.2	Launch the Application.....	22
5.3.3	Splash Screen.....	23
5.3.4	Upload Data Files.....	23
5.3.5	Software Update.....	24
5.3.6	Advanced Configuration Tool.....	24
5.3.7	Switch On/Off User Menu Settings.....	25
5.3.8	Switching On/Off Frequency Selections.....	25
5.3.9	Saving a Configuration.....	26
5.3.10	Configuration Lock Dongle.....	26
5.3.11	Icon Summary.....	28
6.	Loc-10Tx Transmitter.....	29
6.1	Loc-10Tx Transmitter Overview.....	29
6.1.1	Display.....	29
6.1.2	Pushbuttons.....	29
6.1.3	Information Pushbutton.....	30
6.1.4	Connections Block.....	30
6.2	Transmitter Battery.....	30
6.2.1	Removing the Battery Tray.....	31
6.2.2	Replacing the Alkaline Battery.....	31
6.2.3	Rechargeable Batteries.....	31
6.2.4	Re-fitting the Battery Tray.....	31
6.2.5	Rechargeable Battery Pack Charging and Disposal.....	32
6.3	Transmitting Modes.....	32
6.3.1	Induction Mode.....	32
6.3.2	Direct Connection Mode.....	33
6.3.3	Clamp Mode.....	33
6.4	Frequencies.....	34
6.4.1	Frequencies and Power Output.....	34
6.4.2	Most Used Frequencies (Frequency Selection) Feature.....	35
6.4.3	Multi Frequency Mode for Direct Connection.....	36
7.	Loc-5STx Transmitter.....	38
7.1	Loc-5STx Transmitter Overview.....	38
7.1.1	Display.....	38

7.1.2	Pushbuttons.....	39
7.1.3	Information Pushbutton.....	39
7.2	Transmitter Battery.....	39
7.2.1	Removing the Battery Tray.....	39
7.2.2	Replacing the Alkaline Battery.....	40
7.2.3	Rechargeable Batteries.....	40
7.2.4	Re-fitting the Battery Tray.....	40
7.2.5	Rechargeable Battery Pack Charging and Disposal.....	40
7.3	Transmitting Modes.....	41
7.3.1	Induction Mode.....	41
7.3.2	Direct Connection Mode.....	41
7.3.3	Clamp Mode.....	42
7.4	Frequencies.....	43
7.4.1	Frequencies and Power Output.....	43
7.4.2	Most Used Frequencies (Frequency Selection) Feature.....	44
7.4.3	Multi Frequency Mode for Direct Connection.....	45
7.5	Transmitter Battery.....	46
7.5.1	Replacing Alkaline Batteries.....	46
7.5.2	Rechargeable Batteries.....	46
7.5.3	Battery Charging and Disposal.....	47
7.6	Induction Mode.....	47
7.7	Direct Connection Mode.....	48
7.8	Clamp Mode.....	48
8.	Loc-1Tx Transmitter.....	49
8.1	Pushbuttons.....	49
8.2	External Connectors.....	49
8.3	Replacing Alkaline Batteries.....	49
8.4	Rechargeable Batteries.....	50
8.5	Loc-1Tx Transmitter Operation.....	50
9.	Using the vLocPro2.....	51
9.1	Using the Receiver.....	51
9.1.1	Line Locating.....	51
9.1.2	Depth & Current Measurement.....	51
9.1.3	Sonde Location.....	52
9.1.4	Using the Compass (line direction indicator) Feature to Locate Sondes.....	52
9.2	Passive or Active Location.....	54
9.2.1	Passive Locating.....	54
9.2.2	Active Locating.....	54
9.3	Applying the Transmitter's Signal.....	55
9.3.1	Direct Connection.....	55
9.3.2	Clamp (Coupler).....	55
9.3.3	Induction.....	56
9.4	Searching (sweeping) an Area.....	57
9.5	Tracing a Buried Line.....	57

9.5.1	Pinpointing & Confirming the Buried Line.....	57
9.5.2	Distorted Fields.....	58
9.6	Measuring Depth and Current.....	59
9.7	Signal Direction Precision Identification.....	60
9.8	Using the Accessories.....	62
9.8.1	Using the LPC Separation Filter.....	62
9.8.2	Using the Analogue A-frame in Fault Finding.....	62
9.8.3	Using the Analogue Remote Antenna.....	65
10.	Accessories & Options.....	70
10.1	A-frame (Optional).....	70
10.2	Remote Antenna (Optional).....	70
10.3	Loc-10Tx Vehicle Power Lead (Optional).....	70
10.4	Loc-10Tx Outdoor Power Supply (Optional).....	70
10.5	LPC Separation Filter (Optional).....	70
10.6	Receiver Vehicle Charging Lead (Optional).....	71
10.7	Sonde (Optional).....	71
10.8	Clamp (Optional).....	71
10.9	Clamp Extension Rod.....	72
10.10	Lithium-ion Rechargeable Battery Pack (Standard).....	72
10.11	Receiver Battery Charger (Standard).....	72
10.12	USB Cable (Standard).....	72
10.13	Alkaline Battery Holder (Standard).....	72
10.14	Ground Stake (Standard).....	73
10.15	Direct Connection Lead (Standard).....	73
10.16	Loc-1Tx Alkaline Battery Tray (Standard).....	73
10.17	Ground Spool (Optional).....	73
10.18	Banana Plugs Adapter (Optional).....	73
10.19	Loc-5STx Battery Pack (NiMH).....	73
10.20	Loc-5STx Alkaline Battery Tray.....	73
10.21	Loc-5STx/10Tx Charger.....	74
10.22	Loc-10Tx Rechargeable Battery Tray.....	74
10.23	Loc-10Tx Alkaline Battery Tray.....	74
10.24	Live Cable Connector (LCC).....	74
11.	Glossary.....	75

1. General Safety & Care Information

1.1 Who Can Use This Equipment

- This equipment must only be used by people suitably trained in the use of pipe and cable locators.

1.2 Work-site Safety

- Use your company's, or other applicable safety codes and rules when using this equipment.
- Unless having the required authorization, license and appropriate training – **do not** make connections to any pipe, cable or conductor.
- The equipment should not come in contact with corrosive or hazardous chemicals, gases or dust.
- **Do not** directly connect this equipment to cables or pipes that have a potential difference to ground of greater than 25V AC.

1.3 Equipment Safety

- **Do not** open the enclosures (housings) of either the transmitter or receiver.
- Place the ground stake firmly in the ground before connecting the cable from the transmitter.
- **Do not** hold any uninsulated portion of the connection leads & clips when the transmitter is switched on.

1.4 Batteries and Environmental Safety

Vivax-Metrotech products use four types of batteries:

- Alkaline batteries
- Ni-MH (Nickel Metal Hydride) batteries – rechargeable
- Lithium-Ion batteries – rechargeable
- Lithium-Metal batteries – (small non-rechargeable button cells for “clock” applications)

1.4.1 Alkaline Batteries (Non Rechargeable)

- When replacing the alkaline batteries – use only the size and type specified – **do not** mix battery types (rechargeable and alkaline).
- **Do not** mix partially discharged and fully charged cells in the same battery pack – **do not** mix old with new.
- Never attempt to charge alkaline batteries.

1.4.2 Nickel Metal Hydride Batteries (Rechargeable)

- When using rechargeable batteries, **use only the correct charging device** supplied or specified by the manufacturer. The battery pack or the battery charger will contain circuitry to manage the charging process – other chargers (even if they have the same connector, polarity, voltage & current rating will not have the same control circuitry and can cause damage to the product, overheating, and in extreme cases fire or harm to the individual.
- **Do not** assume that if the plug fits, it is the correct charger – a charger with the correct part number **must** be used – just because it is a Vivax-Metrotech charger, and the plug fits **does not** mean it is the correct charger.
- Before using for the first time, charge rechargeable batteries for six hours. If at any time the rechargeable batteries **do not** last as long as anticipated – discharge fully and then charge for six hours.
- Care should be taken when charging batteries – **Never** repeatedly recharge batteries (or turn power off & on) without using the instrument. If used with an inverter in a vehicle – charge the product then unplug the charger and **do not** charge again until the rechargeable batteries have been used for at least ten minutes. Failure to do this could result in the overcharging of the battery which will shorten the life of the battery and could in some circumstances cause overheating or fire.
- If ever the product becomes hot during the charging process, **immediately** unplug the charger and use the rechargeable batteries for at least ten minutes before recharging. If this reoccurs the next time the unit is charged – return immediately to Vivax-Metrotech for repair.
- **Do not** charge batteries for prolonged periods of time without using the locator for at least ten minutes. Charging for

1 General Safety & Care Information

prolonged period of time could overcharge the battery, reduce the battery life and in extreme circumstances cause damage to the locator and fire.

1.4.3 Lithium-Ion Batteries (Rechargeable)

- Lithium-Ion Batteries – some products use Lithium-Ion batteries – the requirements for marking and transportation are still developing. Please contact Vivax-Metrotech before shipping products containing Lithium-Ion batteries or Lithium-Ion battery packs on their own for any “special instructions”.

1.4.4 Lithium Metal Batteries (Non Rechargeable)

- Commonly known as “button cells” these are small – non-rechargeable batteries used to power internal “clocks” within some units (similar to computers). Generally, they have a life of three-five years.
- Under no circumstances should any attempt be made to charge these batteries.
- Dispose of to your company’s work practice/environmental standards, the prevailing laws, or recognized best practice. Always dispose of batteries responsibly.

1.4.5 General Rules regarding Disposal of Batteries

- **Never** disassemble a battery, or battery pack.
- **Never** dispose of in a fire or water.
- Dispose of batteries in accordance with your Company’s work practice/environmental standards, the prevailing laws, or recognized best practice. Always dispose of batteries responsibly.

1.4.6 Transportation of Lithium-Ion and Lithium-Metal Batteries

- The Lithium-Ion and Lithium-Metal batteries used in Vivax-Metrotech products meet the required safety standards and include the designated protection circuitry.
- Recent regulation changes require that when batteries with Lithium-Ion and Lithium-Metal batteries are transported, the packaging **must** include specified warning labels.
- **Please contact Vivax-Metrotech Customer Service (USA 1-800-446-3392, International +1-408-734-1400 (USA Pacific Time Zone)) for more details.**
- Regulations have also changed regarding the shipping of spare battery packs (battery packs that are not inside a product). There are limitations on the weight of the package, and the packaging must be marked with the appropriate warning labels.
- **Please contact Vivax-Metrotech Customer Service (USA 1-800-446-3392, International +1-408-734-1400 (USA Pacific Time Zone)) for more details.**
- Vivax-Metrotech vLoc Series 2 products using Lithium-Ion battery are classified as “not restricted” they can be shipped normally by road/rail/sea & air (passenger & freight aircraft) without restrictions.



IMPORTANT

Remember – Batteries contain dangerous chemicals – They can be affected by many things such as water ingress or heat – In some circumstances they can explode. They also can cause electric shocks!

1.5 Care of Equipment

- Use equipment only as directed in this User Handbook.
- **Do not** immerse any part of this equipment in water.
- Store in a dry place.
- Keep equipment in the case provided when not in use.
- If left for prolonged period of time – remove alkaline batteries.
- Keep unit clean and free of dust and dirt.
- Protect against excessive heat.

1.6 Care when Interpreting the Information provided by the Locator

- Like all locators – this instrument is locating and providing depth and current readings based on electromagnetic signals that radiate from the buried cable or pipe. In most cases these signals will enable the locator to pinpoint both position depth and current correctly.
- **Beware** – in some cases other factors will distort electromagnetic fields radiating from cable or pipe being located, resulting in incorrect information.
- Always locate responsibly, and use information learned during your training to interpret the information provided by the locator.
- **Do not** provide information regarding depth of cable or pipe to anyone unless authorized to do so by your company.
- **Remember** that depth measurements are to the center of the electromagnetic field or pipe – In the case of pipes this may be significantly deeper than the top of the pipe.

1.7 American & Canadian Safety Notices

USA

- This transmitter and receiver comply with the general conditions of operation, pursuant to part 15 of the FCC Rules.
 - CFR 47 Part 2
 - CFR 47 Part 15
- Changes or modifications not expressly approved by the manufacturer could void the user's authority to operate the products.

CANADA

- Equipment is for use by trained operators only, and not for general household or consumer use.
- Operation is subject to the following two conditions: (1) this device may not cause interference, and (2) this device must accept any interference that may cause undesired operation of the device.

EUROPE

- Vivax-Metrotech confirms that the location system is compliant with relevant provision of European directive 1999/5/EC.
 - EN 55011
 - EN 61000-4-2: A1 & A2
 - EN 61000-4-3
 - EN 61000-4-8: A1
 - ETSI EN 300 330-2
 - ETSI EN 301 489-1
 - ETSI EN 301 489-3

2. Service & Support

2.1 Serial Number and Software Revision Number

Always quote your receiver and transmitter model number, serial number and software revision number when requesting product support. They can be found as follows: (for reference only)



1	Model & Serial Number
---	-----------------------



NOTE

The transmitter Model & Serial Number can be found at the bottom of the transmitter and also inside the transmitter between the battery tray and the main module of transmitter.

Software Revision Number: On both receiver and transmitter the software revision number is displayed on the LCD during the startup sequence or can be found in the “About” section of the user menu.

2.2 Distributors and Service Centers Closest to You:

Worldwide Sales Offices and Service Centers	
World Headquarters, United States of America	Central/South America and the Caribbean
<p>Vivax-Metrotech Corporation 3251 Olcott Street, Santa Clara, CA 95054, USA Website : www.vivax-metrotech.com</p> <p>Sales & Sales Support: T/Free : 800-446-3392 Tel : +1-408-734-1400 Fax : +1-408-734-1415 Email : SalesUSA@vxmt.com</p> <p>Service & Repairs: T/Free : 800-638-7682 Tel : +1-408-962-9990 Fax : +1-408-734-1799 Email : ServiceUSA@vxmt.com</p>	<p>Ventas para América Latina 3251 Olcott Street, Santa Clara, CA 95054, USA</p> <p>T/Free : 800-446-3392 Tel : +1-408-734-1400 Fax : +1-408-743-5597 Website : www.vivax-metrotech.com Email : LatinSales@vxmt.com</p>
	France
	<p>Vivax-Metrotech SAS Technoparc - 1 allée du Moulin Berger, 69130 Ecully, France</p> <p>Tel : +33(0)4 72 53 03 03 Fax : +33(0)4 72 53 03 13 Website : www.vivax-metrotech.fr Email : SalesFR@vxmt.com</p>
	United Kingdom
	<p>Vivax-Metrotech Ltd. Unit 1, B/C Polden Business Centre, Bristol Road, Bridgwater, Somerset, TA6 4AW, UK</p> <p>Tel : +44(0)1793 822679 Website : www.vivax-metrotech.com Email : SalesUK@vxmt.com</p>
Canada	
<p>Vivax Canada Inc. 41 Courtland Ave Unit 8, Vaughan, ON L4K 3T3, Canada</p> <p>Tel : +1-289-846-3010 Fax : +1-905-752-0214 Website : www.vivax-metrotech.com Email : SalesCA@vxmt.com</p>	
Germany	
<p>Metrotech Vertriebs GmbH Am steinernen Kreuz 10a D-96110 Schesslitz</p> <p>Tel : +49 954 277 227 43 Website : www.vivax-metrotech.de Email : SalesEU@vxmt.com</p>	
International Distributors and Service Centers	
Australasia	China
<p>Vivax-Metrotech AUS Unit 1, 176 South Creek Road, Cromer NSW 2099, Australia</p> <p>Tel : +61-2-9972-9244 Fax : +61-2-9972-9433 Website : www.vivax-metrotech.com.au Email : sales@vxmtaus.com service@vxmtaus.com</p>	<p>Leidi Utility Supply (Shanghai) Ltd. No. 780, Tianshan Rd, Shanghai, China 200051</p> <p>T/Free : 4008-206-719 Tel : +86-21-5235-3001 Fax : +86-21-5235-8365 Website : www.leidi.cn Email : info@leidi.cn</p>

3. vLocPro2 Receiver

3.1 vLocPro2 Receiver

The vLocPro2 is a Precision Location System designed to meet the needs of utility companies and their contractors. The following describes the features and use of the receiver:



1	Optional Bluetooth Module	6	Charging Socket
2	Pushbutton & Display	7	Mini USB Port Data Transfer and Software Upgrade
3	Carbon Fiber Reinforced Antenna Assembly	8	Accessories Port
4	Accessory & Charging Sockets	9	Model# & Serial#
5	USB Memory Stick Data Transfer, active on some models	10	AA Battery Pack/Rechargeable Battery Pack

3.2 Charging the Receiver Batteries

The vLoc series 2 can be used with either alkaline batteries or it can be supplied with an interchangeable rechargeable battery pack.

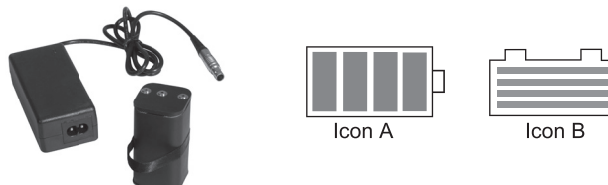

When an alkaline battery pack is used, Icon A will appear on the screen. When the rechargeable battery pack is used, Icon B will be displayed..

In both cases, the number of bars illuminated within the battery icon indicates the amount of charge remaining.

Rechargeable batteries are supplied with a mains charger. This is specific to the batteries, avoid the use of other manufacturers' chargers as these may damage the battery pack and may result in overheating of the battery pack.

To charge the rechargeable batteries, first make sure the pack is inserted in the receiver battery compartment as charging is done inside the receiver.

Connect the charger to the charging socket of the receiver. Connect charger to the mains and switch on. The LED indicator on the charger will illuminate red until the batteries are fully charged at which time the LED will change to green.



WARNING

Rechargeable batteries are supplied with a mains or 12V DC charger. These are specific to the batteries. Only use the charger that is appropriate for the batteries in the product. If in doubt, call Vivax-Metrotech Customer Service. Failure to use the appropriate charger could result in damage to the battery pack, locator and in extreme cases cause fire.

Avoid charging the unit in extreme temperature conditions. (i.e. below 0°C and above 45°C)

Although Vivax-Metrotech batteries include all the required safety related features always immediately discontinue use of the charger and battery pack if the battery pack becomes excessively warm. Return both to where they were purchased for investigation.

Always ensure batteries have at least a partial charge if storing for long periods without use.

Dispose of all batteries in accordance with your company procedures and Federal/State and local regulations.

Never dismantle batteries, put them in fire, or get wet.

3.3 vLocPro2 Receiver Main Display

The vLocPro2 has several display options – the display shown below is representative of the types of display and icons used.

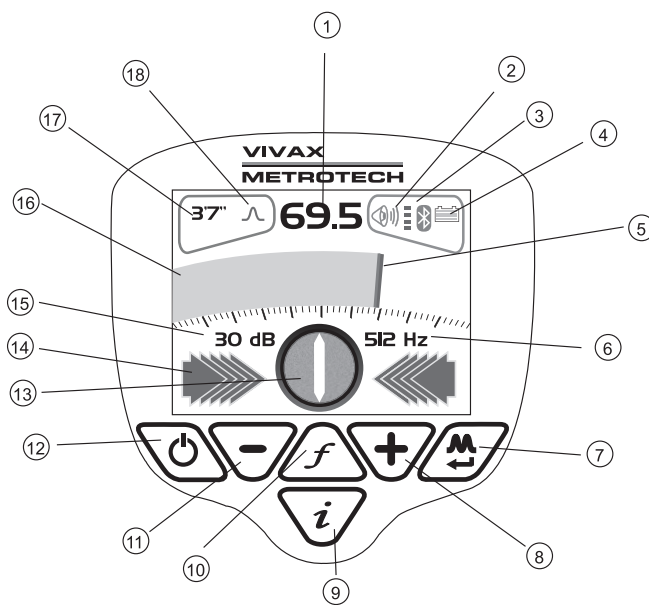

1	Digital Display of Signal Response	10	Frequency Select
2	Loudspeaker Status	11	Gain Control (reduce gain)
3	Bluetooth and GPS Signal Quality	12	On/Off Control
4	Alkaline/Rechargeable Battery Status	13	Compass (line direction indicator)
5	Peak Signal Indication	14	Left vs Right Indication
6	Frequency	15	dB Gain Setting
7	Locate Mode Select	16	Analogue Display of Signal Response
8	Gain Control (increase gain)	17	Continuous Depth/Current
9	Information, Depth/Current Measurement	18	Locate Mode icon (Peak, Null, Sonde, Broad, Peak Arrows)

Note: Bluetooth function is available in vLoc receivers with Bluetooth module only.

3.4 vLocPro2 Receiver Screen Shots

vLocPro2 Receiver Menus (Actual menu may differ)

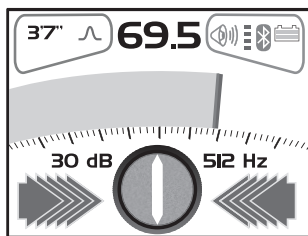

Main Display

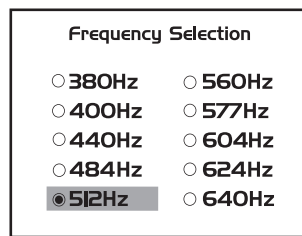

Setup Menu – Frequencies

Frequencies selected here are the only ones displayed in the frequency box on the Main Display

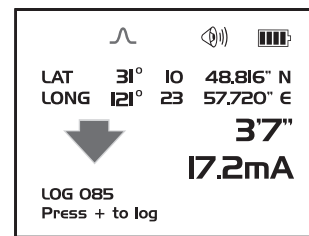

Depth & Current Measurement, Log and GPS

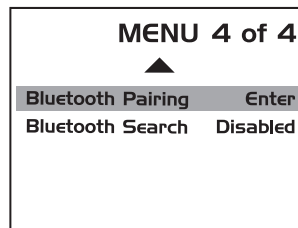
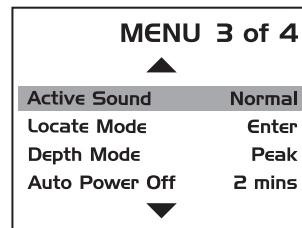
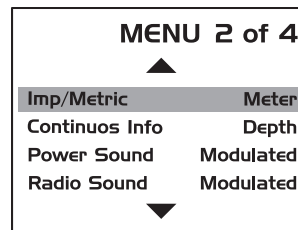
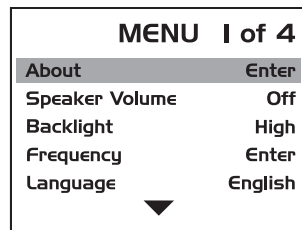

Main Menu

The vLocPro2 is a Precision Location System designed to meet the needs of utility companies and their contractors. The following describes the features and use of the receiver.

3.5 Locating Mode (Response)

The vLocPro2 receiver has four antennas, and these can be toggled through different configurations (modes) to provide different responses to the signals radiating from the buried pipes and cables. The modes are:

3.5.1 Peak Response Mode

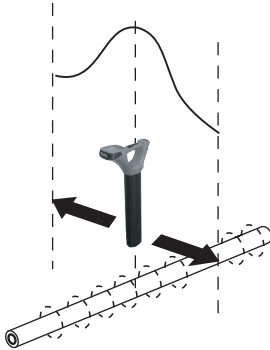
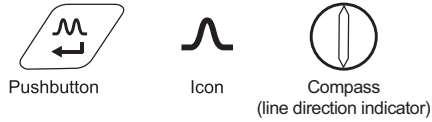

This uses the two horizontal antennas and provides a “Peak” or maximum signal response over the center of the radiated signal from the buried line. The compass (line direction indicator) shows the direction of the cable (available in Active modes). The color of the compass (line direction indicator) changed from clear to blue when the receiver is in line with the buried line.

This is the most accurate of the locating modes as both antennas are used to provide a clearly identifiable “Peak”. In the “Peak” mode, a “Peak signal” indicator helps to clarify the position of the “Peak”. This shows the last “Peak” located for a few seconds, enabling the user to return to that position quickly.

3.5.2 Broad Peak Mode

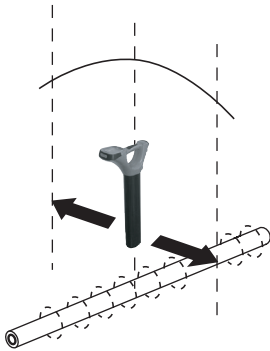
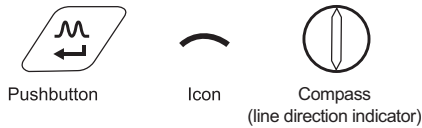

This uses a single horizontal antenna and provides a “Peak” or maximum signal response over the center of the radiated signal from the buried line. The compass (line direction indicator) shows the direction of the cable (available in Active modes). The color of the compass (line direction indicator) changed from clear to blue when the receiver is in line with the buried line.

This is less accurate than the twin horizontal antenna “Peak” mode – but is useful in some particular situations. For pinpointing the line, the “Peak” mode should be used.

3.5.3 Null Mode

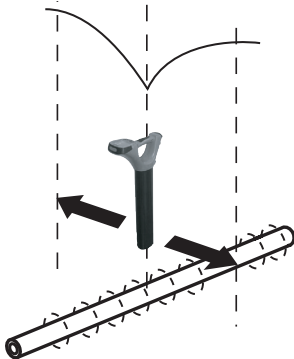
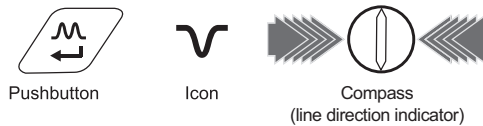

This uses vertical antennas, and provides a minimum or “Null” response over the center of the radiated signal from the buried line. The compass (line direction indicator) shows the direction of the cable (available in Active modes). The color of the compass (line direction indicator) changed from clear to blue when the receiver is in line with the buried line.

Some users prefer the null response; it works well in uncongested areas, but is more prone to inaccuracies due to distortion of the radiated signal in congested areas.

Left/right indication arrows are also displayed when in “Null” mode. The arrows indicate the direction to move the receiver to locate the position of the buried line.

3.5.4 Peak with Arrows Response Mode

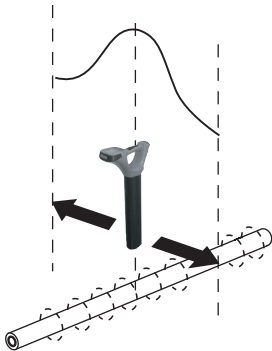
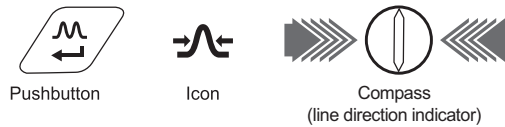

This uses the two horizontal antennas and provides a “Peak” or maximum signal response over the center of the radiated signal from the buried line. The compass (line direction indicator) shows the direction of the cable (available in Active modes). The color of the compass (line direction indicator) changed from clear to blue when the receiver is in line with the buried line.

This is the most accurate of the locating modes as both antennas are used to provide a clearly identifiable “Peak”. In the “Peak” mode, a “Peak signal” indicator helps to clarify the position of the “Peak”. This shows the last “Peak” located for a few seconds, enabling the user to return to that position quickly.

Left/Right arrows also guide the user to the line. However, it should be noted that the arrows use the Null antenna to resolve which arrows are activated. The null antenna is not as accurate in distorted fields as the peak antennas. Therefore, when pinpointing, use the peak bar graph to determine the position of the line.



Note

If the arrows indicated a different position for the cable than the peak bar graph position, this indicates the possibility of a distorted field. Check by taking a depth reading on the ground and then lift the cable locator a known distance such as 1m (3ft). If the depth does not increase by this amount it confirms a distorted field and the data should be treated with caution.

3.5.5 Sonde Mode

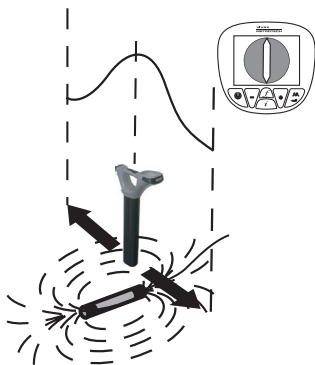
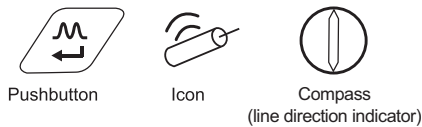

Sonde mode uses the antennas in a “Peak” configuration. An ICON on the display indicates if the receiver is in Sonde mode.

A Sonde is a small transmitting coil that is powered by its own internal battery, or by an external transmitter.

Due to its construction, a Sonde gives a different “Peak” pattern – when locating along the direction of the Sonde – instead of the usual single “Peak”, the Sonde provides three distinct peaks – a small “Peak” – a large “Peak” – a small “Peak”. The Sonde is located under the center of the large “Peak” when located across the direction of the Sonde and it gives the conventional peak response. Note that the Line Indicator points across the line of the Sonde when directly over it and the color of the compass (line direction indicator) change from clear to blue.

3 vLocPro2 Receiver

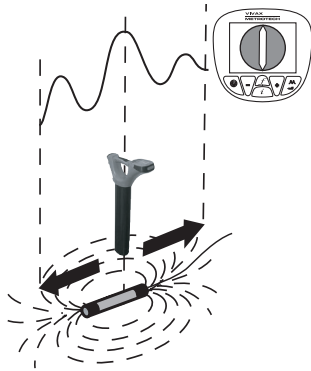

The vLocPro2 receiver must be used in a different orientation when locating a Sonde – due to the way the signal from the Sonde radiates. With the front of the receiver pointing across suspected direction of the Sonde – pinpoint forward and backward (across the Sonde) and then move along the line of the Sonde until the maximum peak is located (in other words rotate the receiver 90 degrees from the orientation normally used when locating pipes and cables).

A Sonde is typically used for locating nonmetallic pipes or ducts, and the camera end of a sewer inspection camera. Low frequency versions (512 Hz/640 Hz) can transmit through some metallic pipes such as cast-iron pipes – which are why they are frequently used with sewer inspection cameras.

For using the compass (line direction indicator) feature to locate Sondes, please refer to 9.1.3.

3.6 Audio



The visual display is also accompanied by an audio response. The output level (volume) of this response is set by entering the "Setup Menu". Press and hold "i" pushbutton for 2 seconds to enter setup menu. The setup display defaults to volume. Use the "M" pushbutton to toggle through the available options (Off – Low – Med – High). Press the "i" pushbutton again to exit the setup menu. As the loudspeaker uses a significant amount of power, using lower volume can make the battery life of the receiver last longer.

3.7 Sensitivity Control

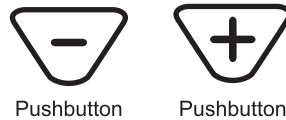

In manual modes, "+" and "-" pushbuttons are provided to increase or reduce the sensitivity of the receiver. If the bar graph moves towards the minimum or maximum a single touch of the opposite pushbutton returns it to approximately 50% deflection. Holding down or repeated pushing of the "+" or "-" pushbuttons increments/decrements the gain.

3.8 Frequency Selection

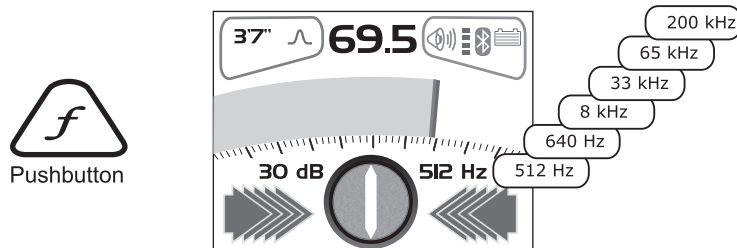

The vLocPro2 receiver is capable of locating a large number of frequencies or frequency combinations. A list of these frequencies can be accessed using the setup menu. Most of these frequencies listed – you will never use – the setup menu

allows you to select the frequencies you wish to use regularly. The frequency select pushbutton on the main receiver pad is used to toggle through the frequencies defined using the setup menu. The operating frequency will be shown at the lower right side of the display. You can change this selection at any time using the setup menu.

The initial frequencies set at the time the unit is supplied are “Power”, “Radio” and the frequencies used by the transmitter purchased. See the transmitter section for suggestions of which frequency is best suited to specific applications.

Frequency Selection	
<input type="radio"/> 380Hz	<input type="radio"/> 560Hz
<input type="radio"/> 400Hz	<input type="radio"/> 577Hz
<input type="radio"/> 440Hz	<input type="radio"/> 604Hz
<input type="radio"/> 484Hz	<input type="radio"/> 624Hz
<input checked="" type="radio"/> 512Hz	<input type="radio"/> 640Hz

To select the frequencies you wish to use regularly – enter the setup menu by pressing and holding the “i” pushbutton for two seconds. Use the “+” and “-” to select the word “Frequency” – then press the “M” pushbutton to display the list of available frequencies.

The “+” and “-” pushbuttons are used to navigate the list of frequencies. To add a frequency to the “Frequently used list” press the “M” pushbutton and a dot will appear in the circle alongside the frequency. To deselect a frequency press the “M” pushbutton and the dot will disappear.

Once your selection is completed press “i” pushbutton once to return to the setup menu, and again to exit the setup menu.

3.9 Information Pushbutton (Depth & Current)



The display shows the following information:

- Icons for signal strength, battery level, and a waveform.
- LAT 31° 10 48.816" N
- LONG 121° 23 57.720" E
- A downward-pointing arrow.
- 3'7"
- 17.2mA
- LOG OBS
- Press + to log

Pressing the “i” (information) pushbutton will display the depth to the center of the radiated signal and a measurement of the current (press the pushbutton briefly – remember if you press and hold – you enter the setup menu. If you do enter the setup menu – press the “i” pushbutton again to return to the locating screen – then try again).

The display above shows Long/Lat positional information. This is only displayed when the equipment is paired with a valid GPS system.



IMPORTANT

When locating a cable or pipe (“Line”) – the instrument should be in “Peak” mode and the depth and current measurements should only be taken with the bottom of the receiver standing on the ground and directly in line with the target line.



IMPORTANT

When locating a Sonde – set the mode to Sonde - then the instrument will automatically be in “Peak” configuration. Depth measurements should only be taken with the bottom of the receiver standing on the ground and at 90° to the Sonde.

The accuracy of depth and current readings depends on the quality of the radiated signal being located. If the signal is symmetrical (undistorted), the depth reading will be accurate to within 5% of the actual depth. If the signal is distorted, depth readings will be less accurate. When taking depth measurement, always hold the receiver at 90° to the ground.

3.10 Information Pushbutton (Setup Menu)

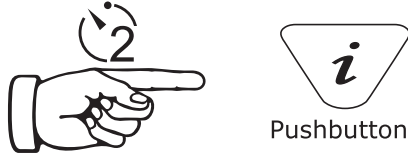

As described previously, a second function performed by the “i” is to access the “Setup menu”. Press and hold the “i” pushbutton for two seconds to display the “Setup menu”. Use the “+”, “-” to navigate through the various options and use the “M” pushbutton to select. To exit the “Setup menu”, press the “i” pushbutton.

The setup menu allows the user to configure their personal preference, this menu can be accessed and changed at any time.









4. vLocML2+ Receiver

4.1 Introduction

The vLocML2+ is a version of the vLoc series locators which can be identified by the loop antenna attached to the base of the locator tube. The purpose of the loop antenna is to energize passive markers buried above nonmetallic services or points of interest.



Markers can be supplied in many sizes or shapes but the most commonly used marker is the ball marker. This has a range of over 1.5m. Markers operate over a range of frequencies. Different frequency markers are used to identify different services and are identified by color. The industry standard colors are listed below:

 Telecom (Orange)	Cable paths, buried splices, buried service drops, load coils, conduit stubs, fiber optic facilities, all types of splices, bends, depth changes, manhole covers, road crossings Frequency: 101.4 kHz
 Power (Red)	Cable paths, service drops, conduit stubs, road crossings, all types of splices, buried transformers, service loops, street lighting, bends, man hole covers, distribution loops Frequency: 169.8 kHz
 CATV (Black & Red)	Cable paths, fiber optic facilities, buried service drops, road crossings, buried splices, bends Frequency: 77 kHz
 Non-Potable Water (Purple)	Reclaimed water, private campuses, valve boxes, road crossings, path making, buried valves, tees, meter boxes, main stubs, service stubs Frequency: 66.35 kHz
 Water (Blue)	Pipeline paths, service stubs, PVC pipeline, all types of valves, road crossings, tees, clean-outs, casing ends Frequency: 145.7 kHz
 Sewage (Green)	Valves, all types of fittings, clean outs, service stubs, laterals, path marking of non-metallic facility Frequency: 121.6 kHz
 Gas (Yellow)	Pipeline paths, main stubs, service stubs, tees, road crossings, all types of valves, meter boxes, stopping fittings, depth changes, transition fittings, squeeze points, pressure control fittings, electro fusion couplings, all types of fittings and joints Frequency: 83 kHz
 EDF Power (Grey Disk)	Gas and electric Installations (EDF only) Frequency: 40 kHz
 Seba Energy (Red & Blue)	Cable paths, service drops, conduit stubs, road crossings, all types of splices, buried transformers, service loops, street lighting, bends, man hole covers, distribution loops Frequency: 134 kHz

4.2 Operating the vLocML2+

The vLocML2+ can be operated in three configurations:

- Standard cable locator
- Dedicated marker locator
- Dual cable locator and marker locator

4.2.1 Switching Between Configuration

There are two ways of switching between configurations:

- Using the user menu
- Using the “M” pushbutton

To use the user menu, press and hold the “i” pushbutton. Use the “+” pushbutton to scroll down to “Marker Locator”. Press the enter key to scroll through the options. Exit the user menu by pressing the “i” pushbutton.



It is possible to hop between configurations using the enter key. To do this press and hold the enter key until the desired configuration is reached.

4.2.2 Standard

In this configuration the unit operates as a standard vLoc cable and pipe locator. For the operation of this see the standard vLoc user handbook sections.

4.2.3 Dedicated

In this configuration the unit is dedicated to locating markers. The screen of the vLocML2+ will look similar to the picture below:

Note that the ball icon  is illuminated indicating that the dedicated configuration is selected. If the line icon  is illuminated with the ball icon, this indicates that the Dual configuration is activated.

It is also possible to take depth to marker estimations in the dedicated mode. (Section 4.2.4)

Use the “f” pushbutton to select the marker type that is to be located.

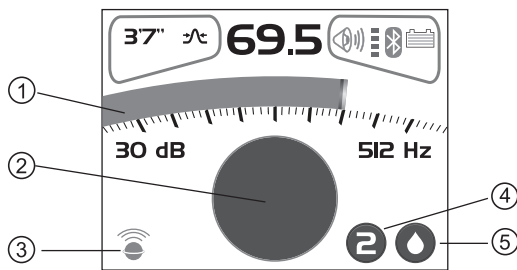

1	Signal strength from Marker used for pinpointing position
2	Marker detection ball (Not adjustable)
3	Marker icon indicating marker detection active
4	Marker type, numeric
5	Marker type, graphic

Sweep the area of where the marker is to be located. Use a slow, deliberate arm sweeping motion slowly moving forward making sure no area is missed.

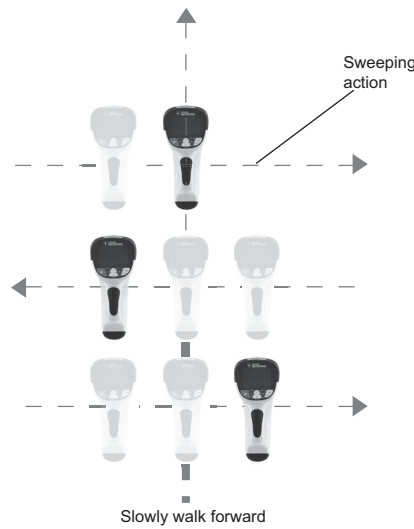

When the locator is within range of the marker there will be a sound from the speaker and also the icon in the center of the display (2) will start to fill up.





Move the locator forward and back, left and right, until the largest signal is detected. Note the bar graph (1) will also respond. Use the “+” and “-” pushbuttons to keep the signal on scale. The bar graph should be used to pinpoint the position of the marker.



4.2.4 Marker Depth Estimation in Dedicated Mode

It is only possible to undertake depth measurement of markers while in the dedicated marker mode.

Procedure:

1. Switch to the dedicated marker mode, make sure that only marker icon is shown in bottom left hand corner of the display
2. Select the appropriate frequency with the “f” button. Icons and colors will indicate you the marker type “gas”, “power”, “water”, “telecom”. Each application has his own frequency (83 kHz for Gas, 101,4 kHz for Telecom, 169,8 kHz for Power USA....) If the colored circle is not empty in a neutral environment (no presence of metal or marker), you can re-calibrate the unit for this frequency by putting it up in the air, and making a long press onto the “f” button. (One-minute operation).
3. Select the desired marker to locate by short pressing the “mode” button. Switching between Automatic , Small Marker , Omni Marker , or Large Flat Marker .
4. If the colored circle is not empty in a neutral environment (no presence of metal or marker), you can re-calibrate the unit for this frequency by putting it up in the air, and making a long press onto the “f” button. (One-minute operation).
5. Pinpoint the position of the marker as previously described.
6. Position the locator on the ground directly over the marker.

4 vLocML2+ Receiver

- Press the "i" button. The display will change to something similar to that shown below.

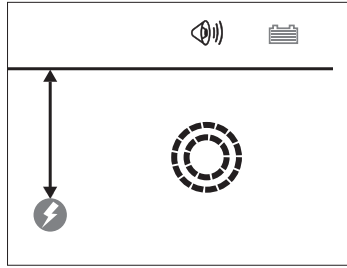

- The rotating symbol indicates that the unit is calculating the depth. Hold the unit vertical and stationary while it calculates. After a few seconds the rotating symbol will disappear and a screen similar to the one below will appear, showing the depth estimation.
- If required, now press the "+" button to log the data into the internal memory.

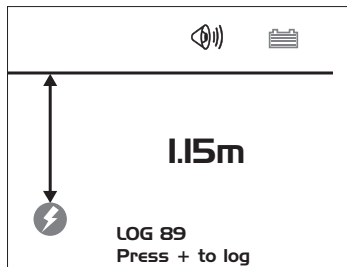

NOTE

If the following display is shown, this indicates that the marker is either out of range or there is an invalid signal.

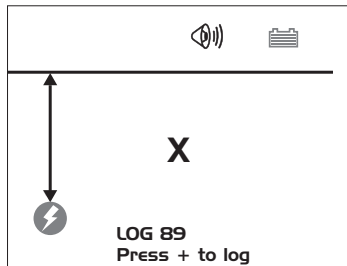

4.2.5 Dual Configuration

In this configuration the unit can be used to trace an energized cable or pipe whilst simultaneously looking for the presence of markers. For example if a cable has markers indicating the position of splices or T joints, the cable can be traced and when a marker is approached the unit will respond indicating the position of the marker.



Enter the dual configuration as previously described. Select the marker type to be detected by pressing and holding the "i" pushbutton to enter the user menu. Use the "+" and "-" pushbuttons to scroll down to "Marker Type". Press the enter key and scroll down to the desired marker. Use the enter pushbutton to select the marker. Exit the user menu by pressing the "i" pushbutton twice.

4 vLocML2+ Receiver

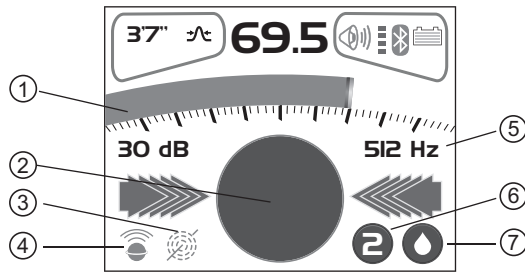
The locator screen will look similar to the picture below.



1	Bar graph showing signal strength from energized line
2	Marker detection ball (Not adjustable)
3	Line icon indicating line locate is active
4	Marker icon indicating marker detection active
5	Line locate frequency
6	Marker type, numeric
7	Marker type, graphic

Note that both icons   are now illuminated indicating that dual configuration is activated. Energize the cable with 512 Hz, 640 Hz or 8.192 kHz as instructed in the vLoc user handbook.

Select the antenna configuration by using the "M" pushbutton. Note that the left/right arrows indicate the cable position and **not** the marker position.

Use the "f" pushbutton to match the transmitter frequency (frequencies up to 33k only are available in dual configuration). Use the locator to identify the position of cable or pipe. Trace the line using the same technique as a standard vLoc locator. The bar graph indicates the signal strength from the cable. Note that in the dual configuration mode the "+" and "-" pushbuttons alter the sensitivity of the cable locate bar graph. It is not necessary to alter the sensitivity to the marker locate function. The sound is from the line position. In dual configuration the marker has no sound associated with it.

As a marker is approached the marker locate icon will start to fill up. Move the locator forward and back, left and right to obtain the largest signal. If pinpointing is required select dedicated configuration and use the bar graph to pinpoint the exact position.

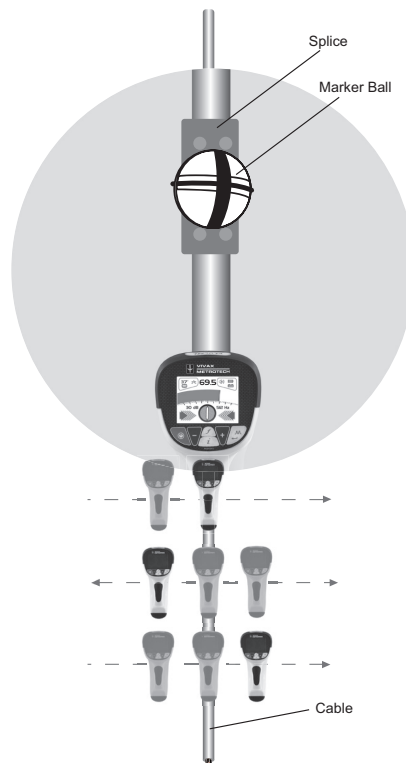

5. Data Logging

The vLoc2 has an internal memory that can be used to store location data. It can store in excess of 1000 records.

To store a record first locate a point of interest. Hold the vLoc stationary over the target and press the "i" pushbutton. When in the depth and current screen, press the "+" pushbutton to save the data. The "Log" number indicates the number of records stored.

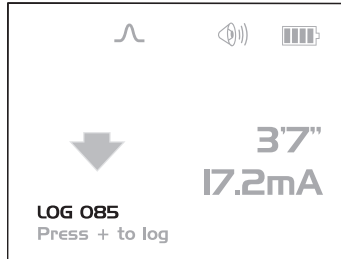

If the GPS function is enabled the GPS coordinates will also be displayed and attached to any saved file. For more information on Data logging and GPS see section 5.2.5.4.

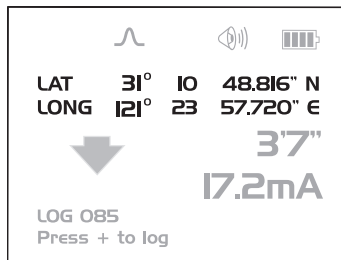

5.1 Bluetooth



As an optional extra the vLocPro2 and vLocML2+ receivers can be fitted with a Bluetooth communications accessory. The Bluetooth option can be retrofitted and can be ordered at a later date if preferred.

5.1.1 Fitting the Bluetooth Module

1. Ensure the unit is switched off.
2. Use a small cross head screw driver to remove the two screws retaining the Bluetooth cover. This is found at the back of the handle near the battery compartment.
3. Remove the cover by sliding it away from the handle.
4. Take the Bluetooth module and carefully slide it into the position the cover was occupying.
5. Replace the two cross head screws.
6. Switch on the unit and after a few seconds a grey, Bluetooth icon should appear showing that the module is fitted.
7. If a red line is shown through the icon, this indicates that the Bluetooth module is not enabled. Bluetooth enable is located in the setup menu which is accessed using a long press of the "i" button.

8. The Bluetooth can communicate with external devices that are also Bluetooth enabled. There are many Bluetooth enabled GPS devices but Vivax-Metrotech offer the Garmin GLO GPS as a suitable solution for those requiring mapping to accuracies better than 5m. For those requiring accuracies better than this, for instance sub-meter accuracy, the customer should contact a GPS supplier of their choice.

5.2 External GPS Devices Overview



Vivax-Metrotech offers the Garmin GLO external GPS device. The Garmin GLO is a simple GPS device with integral rechargeable batteries and Bluetooth communications. It can either be mounted in the purpose designed holder from Vivax-Metrotech or can be positioned anywhere within a few feet/meters from the vLocPro2. For instance using “Velcro” to attach it to the peak of a baseball cap ensures clear view of the sky and satellites.



TIP

For best results allow the GPS indicator to flash at least 15 minutes before commencing a survey.

NOTE: for detailed information check the user instructions provided with your external GPS device.

5.2.1 Pairing with the vLocPro2/vLocML2+ Receivers

1. Switch on the external GPS device and ensure it is within a couple of feet/meters of the receiver.
2. Pairing of the external GPS device with the receiver is achieved through the setup menu. To enter the setup menu press and hold the “i” pushbutton.
3. Press the “+” button to scroll to “Bluetooth Pairing” and press the “M” pushbutton. The vLocPro2 will begin to search for available devices. At the end of the search, a list will be displayed which should include your external GPS device, i.e. “Garmin GLO”. Use the “+” and “-” pushbuttons to highlight this device and press the “M” pushbutton.
4. The vLocPro2 will automatically return to the locate screen. Within 10 seconds the Bluetooth icon will change from grey to blue. This indicates that pairing is successful.



TIP

When not using the Bluetooth function switch off the Bluetooth search function by entering the user menu and deselecting “Bluetooth Search”. This will save battery life and prevent interference from the Bluetooth search activity, in the Radio mode.

When the Bluetooth search function is deactivated a red line will appear through the Bluetooth icon in the locate screen.

5. Next to the Bluetooth icon is the red GPS signal strength bar graph. This will not appear until a valid GPS signal is detected.
6. The bar graph has four levels. For best results, allow a few minutes after the red GPS signal strength bar graph has started before commencing the survey. The accuracy will improve with more bars illuminated.

5.2.2 Gathering Data in Active Modes

Switch on the external GPS device and ensure pairing as indicated above (Bluetooth icon should be blue). Wait for a valid GPS signal as indicated by the red bar graph next to the Bluetooth icon.



TIP

It is a good idea to ensure the datalog is clear before commencing. To do this press the “i” button. While the depth screen is displayed press and hold the “-” button. The message: “Are you sure you want to delete all this datalog Press + key to Delete” will come up. Pressing the “+” key will clear the datalog.

5.2.3 Gathering Data in Power and Radio (Passive) Modes

This is done in the same way as in the active modes except that it is not possible to enter the measure mode unless a valid GPS signal is received from the external GPS device.

Depth and current are not available in the passive modes but all other data can be saved to the datalog.

Locate the cable as described in the vLocPro2 user handbook. Momentarily press the “i” button. A screen similar to the below will be shown:

1	GPS Coordinates
2	Number of records stored

To save a record press the “+” button while in this screen.

5.2.4 Transferring Data from the Locator to a Computer

To transfer data it is necessary to use the vLocPro2 Configurator Tool called MyLocator2. This is a simple program that can be downloaded from the Vivax-Metrotech web site at www.vivax-meterotech.com. The file can be found under the Support/Download Library/Others Download.



TIP

To view Google files it is first necessary to install the Google earth application to your computer. This is a free application which can be found by doing a google search with the words “google earth”.

5.3 Transferring Data from the vLoc2 to a Computer

To transfer data from the vLoc series 2 receiver to a computer requires the use of a simple free of charge software package MyLocator2. It can be downloaded from the Vivax-Metrotech web site www.vivax-meterotech.com.

5.3.1 MyLocator2

MyLocator2 configuration tool is a software package that enables the operator to configure the vLoc series 2 locators. The software is compatible with Window XP, Vista and 7, 8 and 10. To install, use the link on the Vivax-Metrotech web site and follow the installation instructions. A MyLocator2 shortcut icon will appear on your desktop. MyLocator2 is also used to transfer data from the locator to a host computer.

MyLocator2 is under continual development so the following is a guide to its operation but there may be subtle changes to screens etc. However, the guide should still give sufficient information for the user to navigate MyLocator2.

5.3.2 Launch the Application

To launch MyLocator2, double click on the MyLocator2 shortcut icon. If the host computer is connected to the web, it will check to see if MyLocator2 is the latest version. If it is not, it will ask if you wish to install the latest version. Follow the instructions if you wish to install the new version.

MyLocator2 can be operated on different levels. Each level enables different features and functionality. Some levels require a dongle to operate. Dongles are available from Vivax-Metrotech.

In its basic form MyLocator2 allows the operator to:

- Check the software revision number and download the latest version. This feature is useful where software changes have been made to enhance existing features and to install new free of charge features as they become available.
- Upload data files. Files that have been saved in the equipment such as location/GPS data can be transferred to a PC using MyLocator2.
- Adding flash screens: The user can add pictures or company Logos of their choice to the startup screen.

The basic operational screen is displayed below. This will change slightly depending on which tab is active.

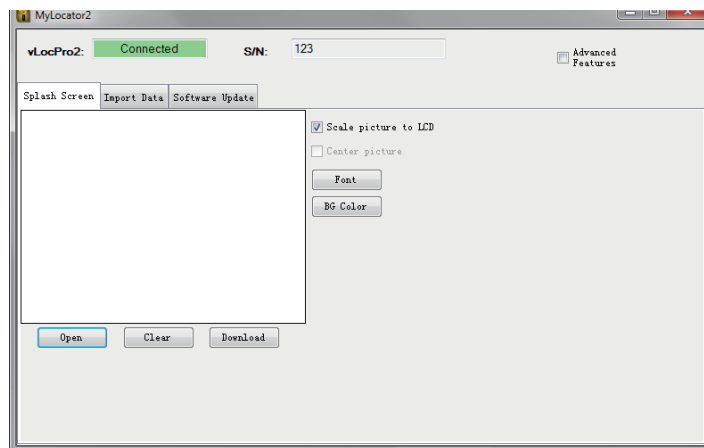

Connect the vLoc Receiver to the PC using a USB to Mini USB cable. The PC should recognize the vLoc and the display will now change to the below or similar.

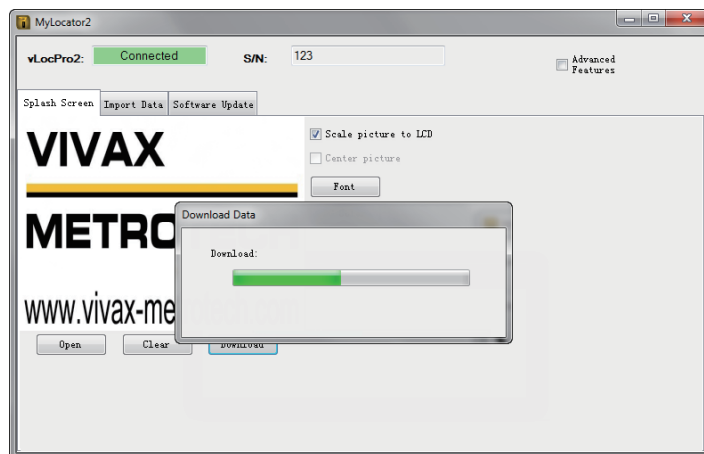

It will now be possible to perform the three operations in the tabs shown.

5 Data Logging

5.3.3 Splash Screen

1. Click the Splash Screen tab. Click on the “Open” button. Browse your computer to find the picture that is intended to be the splash screen.
2. The software will accept the following formats: JPEG, BMP, GIF, PNG, ICO.
3. Select the file and open. The screen below should now also contain a representation of the picture.
4. Press “Download” to transfer the file to the vLoc or “Clear” to remove the file.
5. Clicking on “Scale to LCD” will alter the aspect ratio of the picture to fully fill the screen. Leave this unchecked if no scaling is required. Check the “Centre” button to center the graphic on the screen.

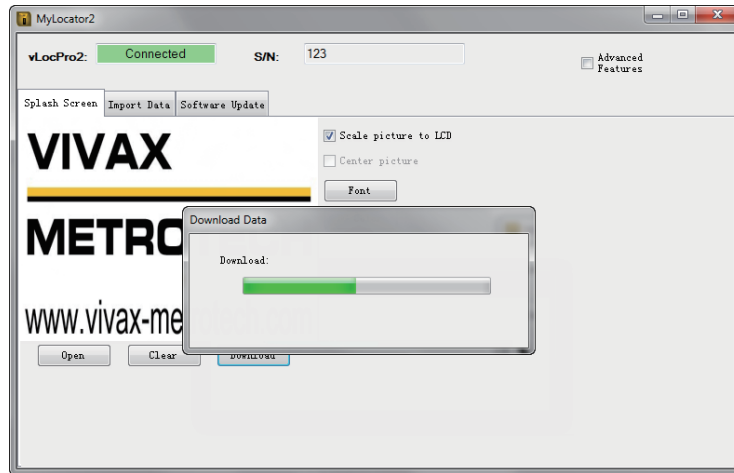

6. Text can also be added to the flash screen.
7. Use the “Text”, “BG Color” (Background color) and “Font” buttons to add text to the startup flash screen.

5.3.4 Upload Data Files

1. Click on the “Import Data” tab. A screen similar to the one below should be shown.
2. Select your preference for Date, Time and Distance.
3. Click on the “Import Data” button.

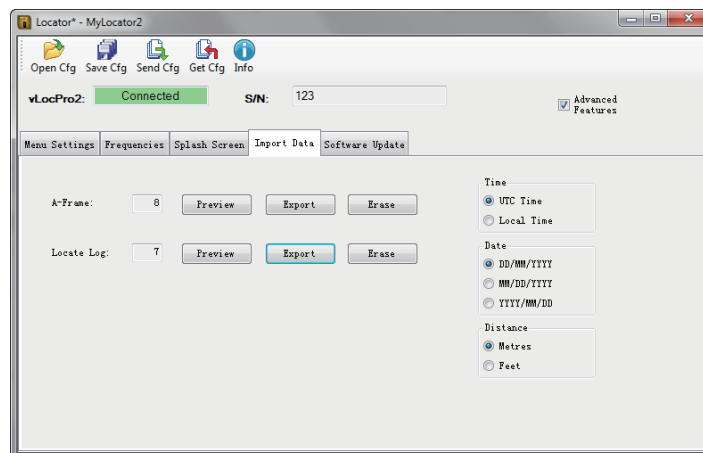

4. When the upload is complete (should only take a second or two) it will be possible to save the data.
5. Press the “Save As” button.
6. Browse your computer files to find the desired file location. Name the file and use the “Windows” pull down tab to select the

5 Data Logging

desired file type (.xl, .txt, .shp, .kml or .csv).

NOTE: if you want to populate the saved log on GOOGLE MAPS application, save the log in .kml format.

7. Press the windows “save” button.
8. Use the “Clear Log” button to clear the log from the locator. Note that this can also be achieved by using a long press on the “-” pushbutton on the locator, when in the depth & current screen.

5.3.5 Software Update

1. With the locator switched on and connected to the computer, click on the “Software Update” tab.
2. A screen similar to the one below should be shown.

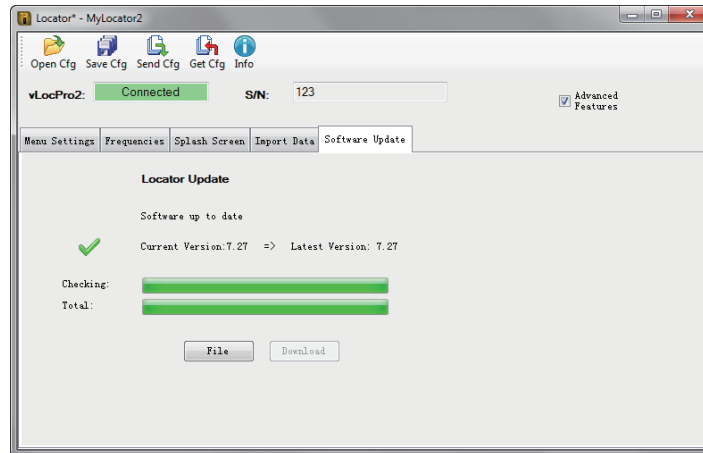

3. If connected to the Web, press the “Get latest sw rev” button. Alternatively, if the software revision required is already saved, use the “File” button to browse to the relevant file.
4. Click on the “Download” button. The progress bars below will start to activate showing the progress of the software installation. When it is complete a message “software upload complete” will be shown both on the computer and locator screen.
5. Note that the new software will not be active until the unit has been switched off and on again.

5.3.6 Advanced Configuration Tool

Clicking the “Advanced” button allows the user to configure the instrument to specific requirements.

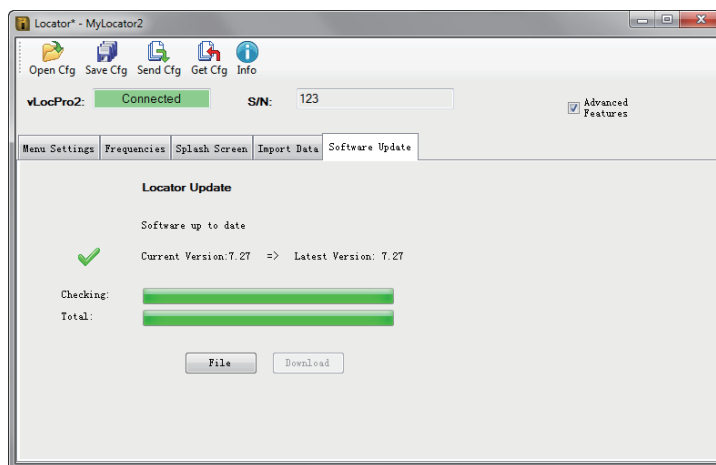

5 Data Logging

The extra features available are:

- Switch on or off user menu settings
- Switch off frequency selections

By doing this the locator is simplified and tailored exactly to the customer requirements.

The configuration can be saved as a “configuration” file and used to configure other vLoc2 locators. This ensures consistency throughout the locator fleet.

5.3.7 Switch On/Off User Menu Settings

1. With the locator switched on and connected to the host computer click on the “Menu Settings” tab.
2. A screen similar to the one below should be shown. If not, click on the “Get Cfg” icon on the top bar. This will load the configuration of the connected locator to the host pc.

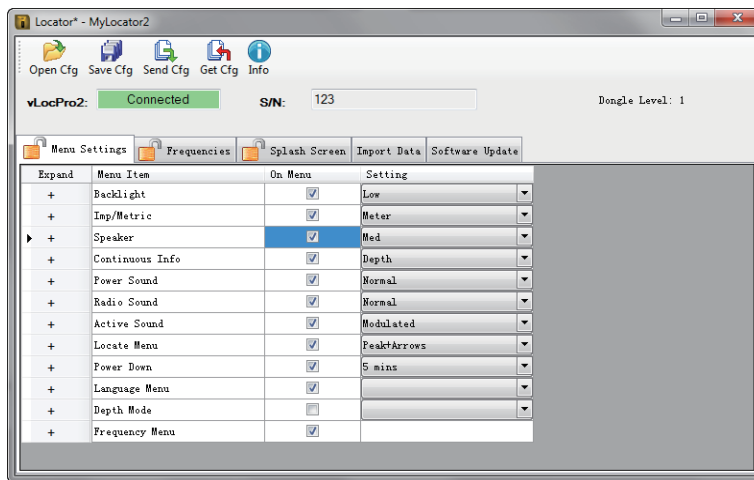

3. Check the boxes that are required to be made available.
4. Click on the pull down menu and select the settings required.
5. Clicking on the “Send Cfg” icon will send the configuration to the locator.

5.3.8 Switching On/Off Frequency Selections

1. Click on the “Frequencies” tab. A screen similar to the one below should be shown.

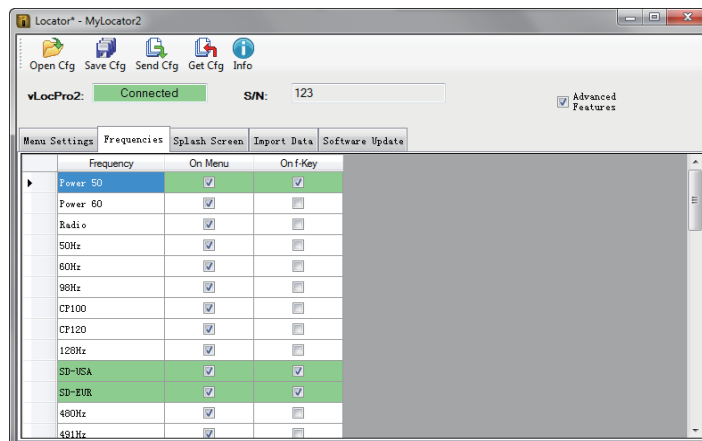

5 Data Logging

2. Each row is color coded:
 - a. **Grey** indicates that frequency is not selected for either the menu or the frequency key.
 - b. **White** indicates that the frequency will be active in the locator menu but has not been selected to show on the frequency key. (Note that it is still possible to make this frequency available on the locator by selecting it in the locator frequency menu.
 - c. **Green** indicates that the frequency will be available both in the locator menu and frequency select key.
 - d. **Blue** shows active line.
3. Make the selections required.
4. Clicking on the "Send Cfg" icon will send the configuration to the locator.

5.3.9 Saving a Configuration

Having created a configuration, it is possible to save this for future use.

To save a configuration:

1. Click on the "Save Cfg" icon.
2. Browse to a desired file location.
3. Create a name for that file, the extension will be: filename.vmcfg.
4. Press "Save" in the window.

To retrieve the file:

1. Click on the "Open Cfg" icon and browse to select the desired file.
2. Click on "open" in the window.
3. The file will populate the MyLocator2 screen automatically with the settings from the configuration file.

5.3.10 Configuration Lock Dongle

A Configuration Lock dongle is available that allows "lockout" of features and functions so that operators are forced to use particular settings. The dongle is also used to unlock these features.

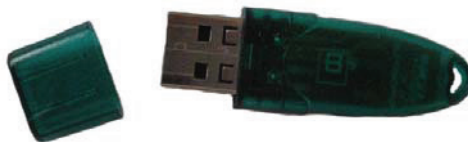

To activate the dongle, plug it into any USB socket on the host computer.

With the dongle active, the MyLocator2 screen will look similar to the picture below.

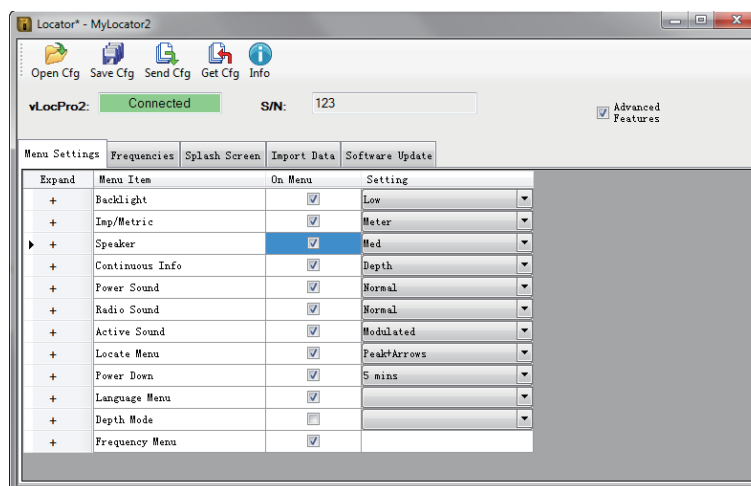

5 Data Logging

Note the padlocks on the three tabs, Menu Settings, Frequencies and Splash Screen.

When a locator is configured with these locks activated, the menu and frequency options in the locators user menu will not appear, stopping the user from altering the settings downloaded to the locator by the Dongle activated MyLocator2 facility.

To activate the padlocks simply double click on the desired tab.

The features can only be re activated by connecting to a host computer with MyLocator2 which has been dongle activated. Double click on the padlocks as before to unlock them and download the changes to the locator.

Example use of the Dongle Lock:

Supposing the Dongle User wishes to force the user to only use 8kHz Peak Mode. The operation would be:

1. Connect the locator to the host computer and switch on. Launch MyLocator2.
2. Click on the "Get Cfg". This will populate MyLocator2 with the Locators configuration.
3. Click on the "Frequency" tab.
4. Uncheck all frequencies except 8.19 kHz.
5. Check both boxes associated with 8.19 kHz as below.
6. Double click on the Frequency tab to lock the padlock.

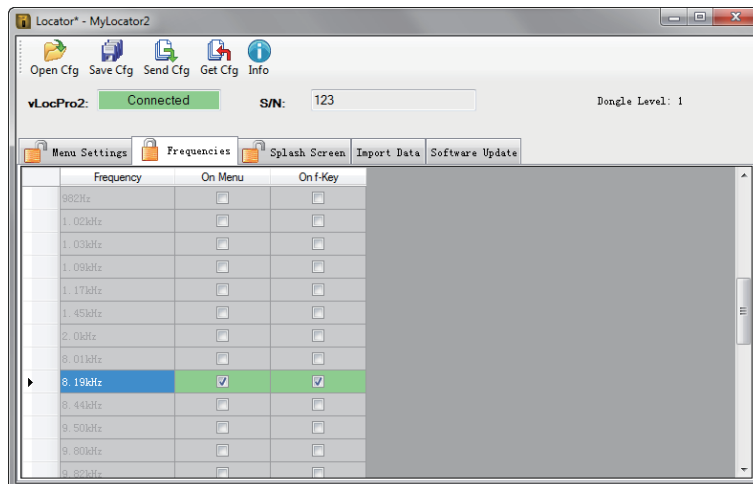



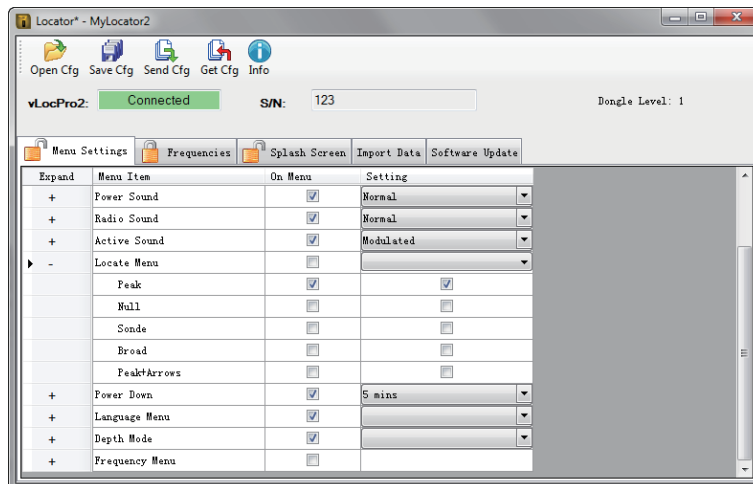

7. Now click on the "Menu Settings" Tab
8. Uncheck the Frequency and all antenna modes except "Peak" as below. Note also the Locate Menu box is un-checked; this will prevent the function appearing in the user menu.
9. Double click on the "Menu Settings" tab to lock the padlock.
10. Now click on the "Send Cfg" icon to send it to the locator.
11. To activate the new configuration switch the locator off and on.

5 Data Logging



5.3.11 Icon Summary

Icon	Function
 Open Cfg	Opens a previously saved configuration.
 Save Cfg	Saves a configuration created by the operator to a file of your choice.
 Send Get	Either "Send" (saves) configuration to a locator or "Get" (copy) a configuration from a locator.
 Clear	"Clears" a configuration created on the configuration tool.

6. Loc-10Tx Transmitter

6.1 Loc-10Tx Transmitter Overview

The Loc-10Tx transmitter is a rugged portable transmitter powered by alkaline “D” cells or Ni-MH (Nickel Metal Hydride) rechargeable batteries. The following describes the features and uses of the transmitter.

6.1.1 Display

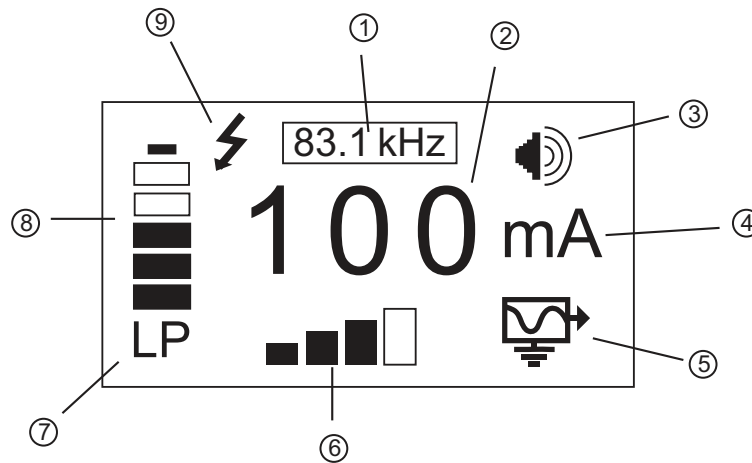

1	Frequency Being Transmitted	6	Output Setting (Step) (filled box indicates current level has been reached, empty box indicates requested current level has not been achieved)
2	Digital Read Out (mA, volts, ohms)		
3	Loudspeaker Level	7	Low Power Indicator (enabled automatically when battery becomes one bar)
4	Units (mA, volts, ohms)	8	Battery Status
5	Mode Indication Icon	9	High Voltage Warning* (output is enabled for high voltage)



External Voltage Warning

The transmitter checks the line when connected. If the line is carrying voltages in excess of 25V, it will display the “high voltage” warning icon, and not allow the transmitter to operate. In addition, the transmitter is protected by a 1.5A/250V fuse in the event of excessive voltage or voltage spikes on the line.

6.1.2 Pushbuttons

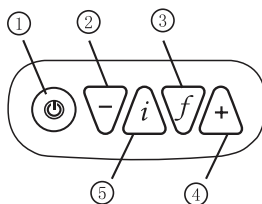

1	On/Off Control
2	Output Decrease/Navigate through menu
3	Frequency Select
4	Output Increase/Navigate through menu
5	Information (Volume, Volts, Ohms, LCD Contrast, Multi-frequencies, Frequency Menu)

6.1.3 Information Pushbutton

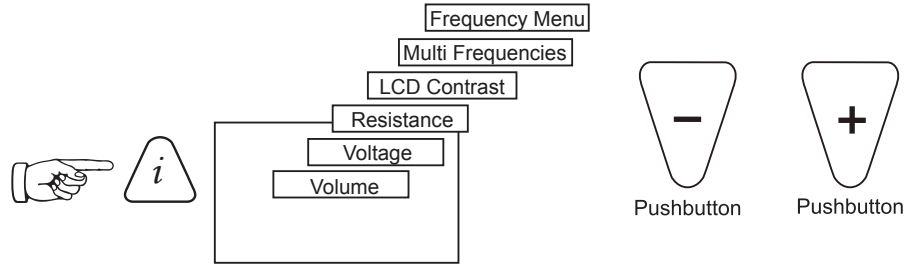

When the “i” (information) pushbutton is pressed, the display will show the volume level of the audio; use the “+” and “-” pushbuttons to increase/reduce the volume or turn the beeper off (off – low – medium – high).

By pressing the “i” (information) pushbutton the display can be toggled to show “voltage” and “resistance”. The display indicates mA, as the default, and volts or ohms when selected.

6.1.4 Connections Block

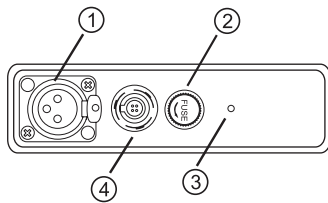

1	Output Connection
2	Output Protection (Fuse)
3	Loudspeaker
4	Battery Charging Socket & DC Input

All the connections made to the transmitter are made at the connection block except for a USB socket which is mounted inside the battery compartment and is used for transmitter’s software upgrade.

The connection block consists of:

- Output (XLR) socket – for the direct connection lead and clamp.
- Charger socket (to charge rechargeable battery pack – the charging socket is present even if re-chargeable batteries have not been purchased).
- Transmitter 12V DC power lead used to power the transmitter from a vehicle (not for charging).
- Fuse – this protects the transmitter circuitry in the event of the transmitter receiving up to 250V incoming voltage on the output leads, or higher than allowed current.
- A beeper is positioned behind the small hole.

6.2 Transmitter Battery



In most markets the transmitter is shipped with alkaline batteries (12 x D cells) unless rechargeable batteries are specified. Batteries are fitted into quick release trays – the alkaline is an open pack, to enable the batteries to be changed. The rechargeable pack is a sealed unit containing Ni-MH (Nickel Metal Hydride) batteries. These packs can only be fitted in a manner to ensure that the alkaline batteries cannot be inadvertently charged.

The battery condition (charge) is displayed on the left side of the display. “LP” letters appears when the battery charge becomes one bar.

6.2.1 Removing the Battery Tray

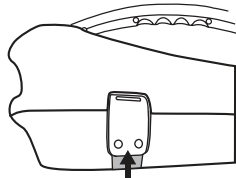

Push up button

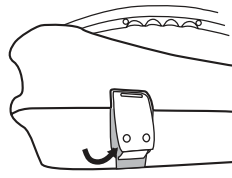

Pull out bottom of catch

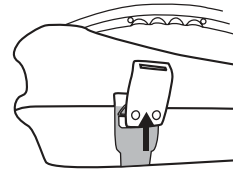

Lift up catch until it clears catch plate

6.2.2 Replacing the Alkaline Battery

- To access batteries – undo stainless steel screws on each battery cover.
- To remove batteries – turn tray upside down and give a short sharp tap of the battery tray on your hand.
- Replace batteries with new batteries of the same type, be sure not to mix old and new batteries.
- **Do not** use rechargeable batteries in the alkaline battery tray. Ensure that batteries are inserted the correct way (see label and molded “+” and “-” in the bottom of the tray).
- Refit the battery cover – then refit the battery tray.



WARNING

Alkaline Batteries – insert alkaline batteries (x12) as shown:

6.2.3 Rechargeable Batteries

- **Do not** attempt to replace the rechargeable batteries or remove battery covers – return to Vivax-Metrotech or a Vivax-Metrotech approved service centers for replacement.



WARNING

Use only Vivax-Metrotech recommended charger.

6.2.4 Re-fitting the Battery Tray

To close battery tray – slide transmitter (TX) onto tray, it will locate itself in the correct position, then close the catches.

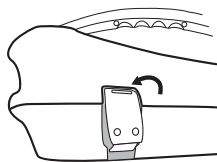

Place top of catch over catch plate

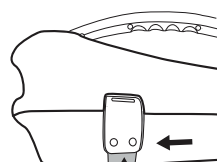

Push up button underneath the catch – where holding that up push in the bottom of the catch. You will hear a positive “click” (**Do not** force catches).



WARNING

Power “IN” socket

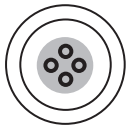

**Two pins are used for power in from charger (to charge rechargeable batteries).
Two pins are used for power from external 12V DC source. A 12V DC power cable is supplied and is designed to be connected to an automobile cigarette lighter socket.**

6.2.5 Rechargeable Battery Pack Charging and Disposal

Follow instructions detailed in the General Safety & Care portion of this document. Only use the battery charger supplied. Using a un-approved charger may damage the battery pack and could cause overheating.

To charge, the rechargeable batteries pack must be connected to the transmitter. Connect the mains charger to the charging socket on the side of the transmitter and connect the charger to a suitable mains socket.

The LED on the charger will show a red light indicating that the charge cycle is in progress. When the batteries are fully charged the LED will change to green.



NOTE
Rechargeable pack cannot be charged from a 12V DC source.

6.3 Transmitting Modes

The transmitter has three transmitting modes, which are selected automatically.

6.3.1 Induction Mode

This uses an internal antenna to induce a locating frequency onto the target pipe or cable (line). “Induction” mode is automatically selected if no connection accessories are plugged into the “output socket”. An icon indicating “Induction” mode shows on the display. The icon flashes when the transmitter is transmitting. In order to generate successful induction, the transmitter should be positioned over and with the handle in line with the target line.

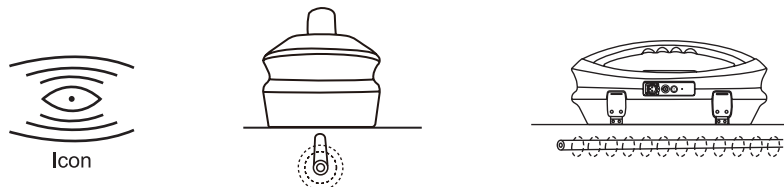

“Induction” mode is generally used when no access is available to make a direct connection, or a clamp connection. When using induction, it is very likely that the signal being induced onto the target line will also be induced onto other lines in the area, and onto above ground features such as wire fences. This can influence the accuracy of the location, depth and current measurements. “Induction” mode is also the least efficient way of applying the transmitting signal to the target line. The distance located with “Induction” mode is generally much less than that achieved with a direct connection or clamp connection.

“Induction” mode generally works better in higher frequencies. The advantage of induction is that no access is required to “connect” the transmitter, making it a very quick process. The antennas on the transmitter are tuned to induce specific frequencies or range of frequencies. Therefore, only a limited number of frequencies can be selected in “Induction” mode.

All the frequencies in favorite frequencies mode that are higher than 8 kHz can be selected by pressing “f” pushbutton in main display. Multiple induction frequencies are available based on the user selection. See section 6.4.2 for adding and removing frequency from the favorite frequencies list.



NOTE

For accurate location and depth measurement the locator receiver should be used no closer than 50ft (15m) from the transmitter.

6.3.2 Direct Connection Mode

By plugging in a connection lead to the output socket, “Direct connection” mode is selected. An icon confirming this is shown on the display. The wave in the icon fluctuates when the transmitter is transmitting. The direct connection lead consists of two cables, one (red clip) must be connected to the conductor being located, the other (black clip) to a suitable ground (a ground stake is provided with the transmitter). An auxiliary ground lead is also supplied. If the auxiliary ground lead is used, the ground clip of the connection lead (black clip) is attached to one end of the auxiliary ground lead.

A good connection is indicated by a change in beep rate from the speaker and the current reading on the display.

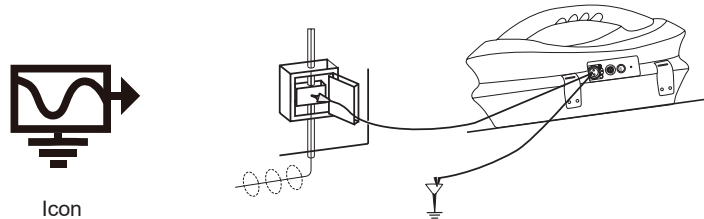

Wherever a direct connection can be safely made without the risk of injury, damage to customer’s plant, or the transmitter, it is the best way of applying the transmitter’s signal.

The coupling of the transmitted signal to other pipes and cables in the area will be much less than with induction, although where commonly bonded systems are encountered – coupling cannot be avoided.

The positioning of the ground connection can also influence the degree of coupling experienced. Ground connections generally should not be made to other pipes or cables, or above ground metallic structures such as wire fences. In general, the lower the frequency is, the further the signal will travel, and the less signal coupling will occur. The most common frequencies used for direct connection are between 512 Hz/640 Hz and 8 kHz.

Regulations in many countries require that power output is limited above certain frequencies. The Loc-10Tx enables frequencies below 45 kHz to be transmitted using as much as 10 watts output, but frequencies over 45 kHz are restricted to 1 watt. Using direct connection and the higher power at the low frequencies helps significantly in achieving greater location distances. Direct connections should not be made to cables carrying greater than 25V (or as your safety practices allow). The transmitter is protected (250V fuse) from stray currents that may exist on the target line.

6.3.3 Clamp Mode

Plugging the signal clamp supplied by Vivax-Metrotech into the output socket will place the transmitter in “Clamp” mode. An icon confirming this is displayed on the display. The icon flashes when the transmitter is transmitting. When using the clamp, no ground connection is needed.

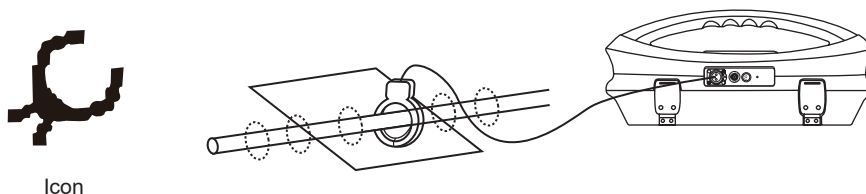

The clamp again is a precise way to apply the locating signal. It is generally used when access to the conductor cannot be achieved to make a direct connection (but there is sufficient access to place the clamp around the cable), or when it is not safe to make a direct connection because the target cable is carrying electricity.

The clamp is a specialized inductive device (sometimes known as a toroid or coupler). All clamps are optimized to work at specific frequencies. In most cases clamps are designed to be used at frequencies generally between 8 kHz and 83 kHz. The transmitter will only allow the selection of a suitable range of frequencies for your clamp.



WARNING

When applying the clamp to cables that carry electricity – be sure to follow your company’s safety instructions and procedures. Beware that if applied around a high voltage cable – that cable may induce a current in the clamp causing it to snap shut or jump quite dramatically – always apply clamps carefully.

6.4 Frequencies

6.4.1 Frequencies and Power Output

The Loc-10Tx transmitter is supplied with a predefined set of transmit frequencies. The most commonly used frequencies will be preset by the factory. Additional frequencies are available to select in the frequencies list see section 6.4.2.

Example of standard frequencies/preset at the factory are:

- 512Hz (where electrical systems are 60Hz) direct connection – 10-watts.
- 640Hz (where electrical systems are 50Hz) direct connection – 10-watts.
- 8 kHz direct connection – 10-watt.
- 33 kHz direct connection – 10-watt.
- 65 kHz direct connection – 1-watt.
- 83.1 kHz, 131 kHz direct connection – 1-watt (depending on region).
- 200 kHz direct connection – 1-watt (depending on region).
- Some other frequencies with 10-watt output:
 - o Direction connection: 256Hz, 491Hz, 982Hz, etc.
 - o Direct and clamp connection : 8.19 kHz, 8.44 kHz, 9.5 kHz, 9.82 kHz, 32.8 kHz, 38 kHz.
- Some other frequencies with 1W output: 89 kHz, 131 kHz, 200 kHz.
- Clamp connection: any frequency from 8 kHz up to the highest allowed frequency (depending on region).
- Induction Frequency: this transmitter is a broad-band induction unit. It means that user can select for the Induction mode any frequency he wants, from 8 kHz up. (highest available frequency depends on region)

NOTE: see section 6.4.2 for frequency activation procedure.

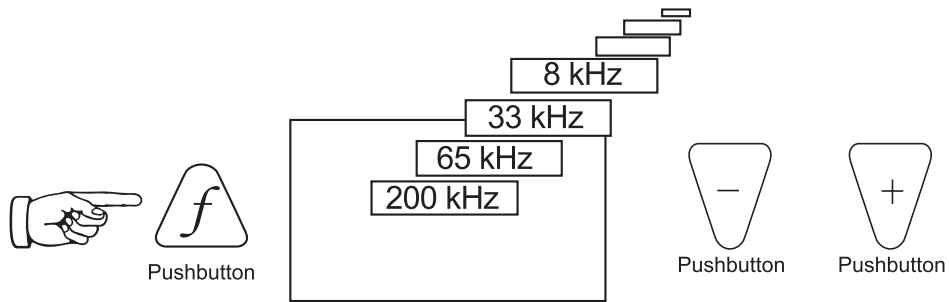

As with most manufacturers the clamps and induction antennas are tuned to specific frequencies, and do not work over the complete range of frequencies.

Frequencies are selected by pressing the “f” pushbutton which toggles through the available frequencies for the selection mode. The frequency is automatically selected if you don’t toggle past it within two seconds. The frequency is shown on the display.

NOTE:

The output current is shown in large characters on the display – to increase or reduce the power output press “+” or “-”. The vertical bar graph at the bottom of the display indicates which of the four current output steps is being used. If the transmitter can supply the requested current, the bar will turn black. If the bar does not turn black, improving the ground connections or wetting the ground where the earth stake is positioned, may help. However, it may not be able to achieve the current setting requested because the impedance of the line is too high for this setting. If this happens it is best to select a setting that has a black bar, this will ensure a stable output.

The current being transmitted will be limited by the impedance of the cable, therefore it is not unusual to increase the output level, but see no increase in the current displayed. This is not a fault with the transmitter.

The transmitter will always revert to first level output when switched on – this is a power saving feature – in most circumstances this output level is sufficient. Increasing the output power unnecessarily will reduce the battery life unnecessarily. All other settings remain the same as the last setting used.

6.4.2 Most Used Frequencies (Frequency Selection) Feature

This feature can be used to allow operator to choose his most used frequencies from a list of possible frequencies. Once these frequencies are selected in the main menu, pressing the “f” pushbutton, user can scroll through them. At any time, user can add or remove frequencies from the above list, following the below procedure. Maximum frequencies that can appear in most used frequencies list is 12.

The advantage of this feature is that user can optimize the transmitter and activate at the main menu user’s preferred frequencies, instead of having a whole list of frequencies that user has to scroll through.

To enter the "Frequency Menu" proceeds as follows:

1. Press the “i” pushbutton four--six times (based on the mode that transmitter is in), until get to the "Frequency menu" sub-menu.

In Direct Connection mode,

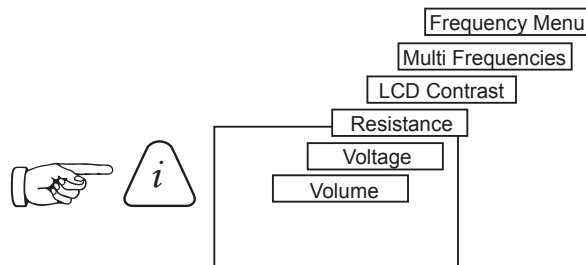

In SD mode,

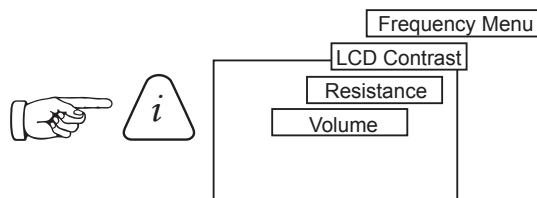

6 Loc-10Tx Transmitter

In Clamp mode,

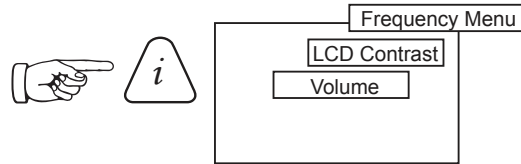

2. Screen will show a list of frequencies available, with the central one in a box.

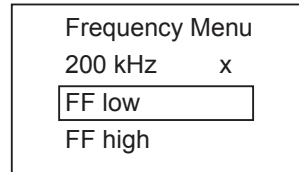

3. Pressing the "+" or "-" pushbuttons, you can scroll up or down through the available frequencies.
4. Once the wanted frequency is inside the box, press "f" pushbutton to select or deselect the frequency. An "x" will appear in the box for a selected frequency.

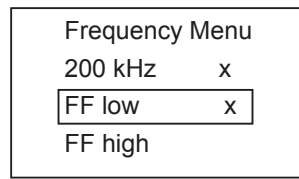

5. After selecting the frequencies, press the "i" pushbutton again to exit the "Frequency Menu" and return to the main display.
6. A particular frequency in the chosen list of frequencies can be selected from the main display screen by pressing the "f" pushbutton until the wanted frequency is displayed at the top of the main screen.

6.4.3 Multi Frequency Mode for Direct Connection

This feature can be used when user wants to energize on target two to three frequencies at the same time. Mainly, it can be used when user is not sure which frequency can be impressed better into the target. Multi frequency mode is not available in Fault Find and SD modes.



NOTE

- When using multi-frequency mode, total power will be split between the activated frequencies.
- The frequencies have to be available in the main menu.

6 Loc-10Tx Transmitter

To enter the "Multi-Freq. Setup" menu, proceeds as follows:

1. Press "i" pushbutton five times to get to the "Multi-Frequency" screen and press "f" pushbutton to activate the multi frequency mode. An "x" symbol will appear indicate the multi frequency mode is activated. Press "f" pushbutton again to go in "Multi-Freq. Setup" screen to choose the frequencies.

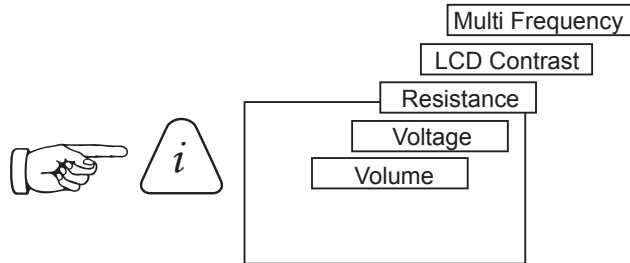

2. Use the "+" and "-" pushbuttons to scroll through the available frequencies and bring the wanted one in the first box.

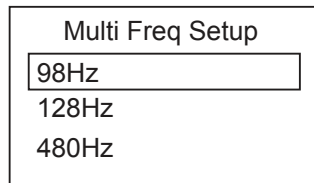

3. Press "f" pushbutton to move the box down and the "+" and "-" pushbuttons to select the second frequency.

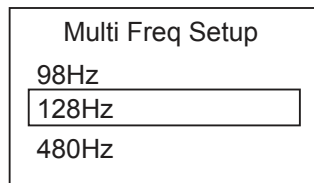

4. Repeat step three to select the third frequency if needed.
5. Press "i" pushbutton to return to main display. On the main display, "Multi" will appear indicating the multi-frequency mode is active.

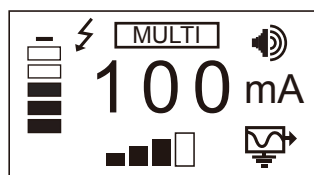

6. The frequencies selected for multi-frequency mode will be saved until changes are made even when the multi-frequency mode is deactivated.

7. Loc-5STx Transmitter

7.1 Loc-5STx Transmitter Overview

The Loc-5STx transmitter is a rugged portable transmitter powered by alkaline “D” cells or Li-Ion rechargeable batteries. The following describes the features and uses of the transmitter.



1	Pushbutton controls
2	LCD Display
3	Single Output Connection (Loc-5STx)
4	Blanking Plate
5	Piezo beeper
6	Battery compartment

- A USB socket is mounted inside the battery compartment and is used for transmitter’s firmware upgrade.
- The beeper is positioned behind a small hole on one side of the housing.

7.1.1 Display

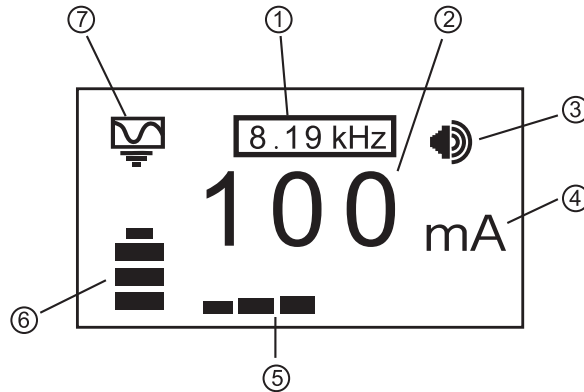

1	Active Frequency	5	Output Setting (Step) (filled box indicates current level has been reached, empty box indicates requested current level has not been achieved)
2	Digital Readout (mA, volts, ohms)	6	Battery Status
3	Beeper Level	7	Mode Indication Icon
4	Units (mA, volts, ohms)		



External Voltage Warning

The transmitter checks the line when connected. If the line is carrying voltages in excess of 25V, it will display the “high voltage” warning icon, and not allow the transmitter to operate. In addition, the transmitter is protected in the event of excessive voltage or voltage spikes on the line.

7.1.2 Pushbuttons

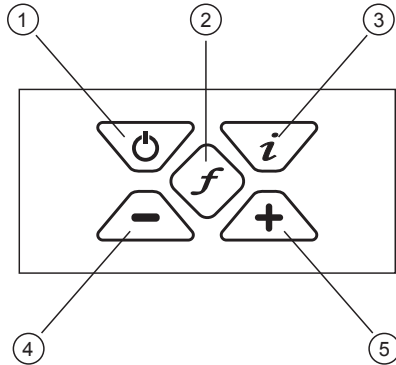

1	On/Off
2	Frequency Select
3	Information (Volume, Volts, Ohms, LCD Contrast, Multi-frequencies, Frequency Menu)
4	Output Decrease/Navigate through menu
5	Output Increase/Navigate through menu

7.1.3 Information Pushbutton

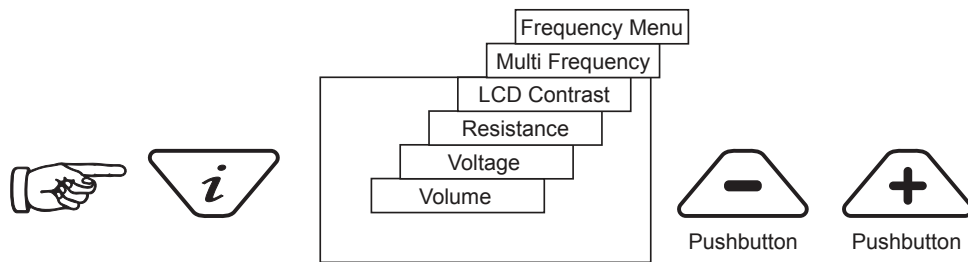

When the “i” (information) pushbutton is pressed, the display will show the audio volume level , use the “+” and “-” pushbuttons to increase/reduce the volume or turn the beeper off (off – low – medium – high).

By pressing the “i” (information) pushbutton the display can be toggled to show “voltage” and “resistance”. The display indicates mA, as the default, and volts or ohms when selected.

7.2 Transmitter Battery



By default, transmitters are shipped with eight D cell alkaline batteries. A rechargeable Li-Ion (Lithium-Ion) battery kit is available as an accessory. The battery status is displayed on the left side of the display.

The letters “LP” will appear when the battery status reaches only one bar. At this battery level the max output current and power is limited.

7.2.1 Removing the Battery Tray

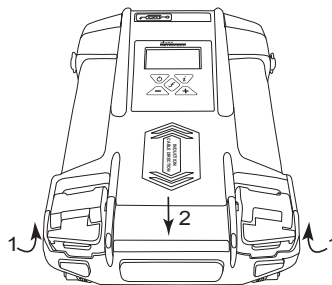

7.2.2 Replacing the Alkaline Battery

- To access batteries – undo the two latches that are locking the battery cover.
- To remove batteries – remove the battery holder from the inside of the unit.
- Replace batteries with new batteries of the same type, be sure not to mix old and new batteries.
- **Do not** use rechargeable batteries in the alkaline battery tray. Ensure that batteries are inserted the correct way (see label and molded “+” and “-” in the bottom of the tray).
- Refit the battery tray – then close the battery cover.



WARNING
Alkaline Batteries – insert alkaline batteries (x 8) as shown:



7.2.3 Rechargeable Batteries

- **Do not** attempt to replace the rechargeable batteries or remove battery covers – return to Vivax-Metrotech or a Vivax-Metrotech approved service center for replacement.



WARNING
Use only Vivax-Metrotech recommended charger.

7.2.4 Re-fitting the Battery Tray

To close the battery compartment – place the two catches into their position, then close the catches.

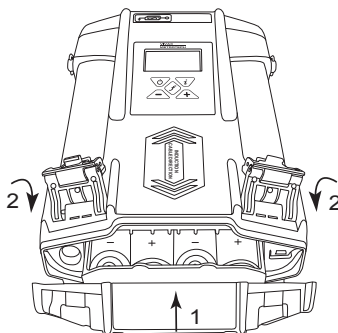

7.2.5 Rechargeable Battery Pack Charging and Disposal

Follow the instructions in the General Safety & Care section portion of this document.

Only use the battery charger supplied with the battery. Using a non-approved charger may damage the battery pack and could cause overheating.

The rechargeable battery pack must be connected to the transmitter in order to charge. Connect the charger to the charging socket on the inside of the transmitter and connect the charger to a suitable mains socket.

The LED on the charger will show a red light indicating that the charge cycle is in progress. When the batteries are fully charged the LED will change to green.

**NOTE**

Rechargeable pack cannot be charged from a 12V DC source.

7.3 Transmitting Modes

The transmitter has three transmitting modes, which are selected automatically.

7.3.1 Induction Mode

This uses an internal antenna to induce a locating frequency onto the target pipe or cable (line). “Induction” mode is automatically selected if no connection accessories are plugged into the “output socket”. An icon indicating “Induction” mode shows on the display. The icon flashes when the transmitter is transmitting. In order to generate successful induction, the transmitter should be positioned over and with the handle perpendicular to the target line.

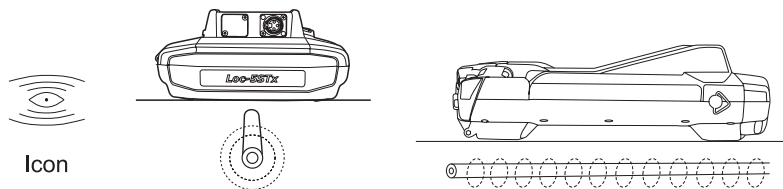

“Induction” mode is generally used when no access is available to make a direct connection, or a clamp connection. When using induction it is very likely that the signal being induced onto the target line will also be induced onto other lines in the area, and onto above ground features such as wire fences. This can influence the accuracy of the location, depth and current measurements. “Induction” mode is also the least efficient way of applying the transmitting signal to the target line. The distance located with “Induction” mode is generally much less than that achieved with a direct connection or clamp connection.

“Induction” mode generally works better in higher frequencies. The advantage of induction is that no access is required to “connect” the transmitter, making it a very quick process. The antennas on the transmitter are tuned to induce specific frequencies or range of frequencies. Therefore only a limited number of frequencies can be selected in “Induction” mode.

All the frequencies in favorite frequencies mode that are higher than 8 kHz can be selected by pressing “f” pushbutton in main display. Multiple induction frequencies are available based on the user selection. See section 7.4.2 for adding and removing frequency from the favorite frequencies list.

**NOTE**

For accurate location and depth measurement the locator receiver should be used no closer than 50ft (15m) from the transmitter.

7.3.2 Direct Connection Mode

By plugging in a connection lead to the output socket, “Direct connection” mode is selected. An icon confirming this is shown on the display. The wave in the icon fluctuate when the transmitter is transmitting. The direct connection lead consists of two cables, one (red clip) must be connected to the conductor being located, the other (black clip) to a suitable ground (a ground stake is provided with the transmitter). An auxiliary ground lead is also supplied. If the auxiliary ground lead is used, the ground clip of the connection lead (black clip) is attached to one end of the auxiliary ground lead.

A good connection is indicated by a change in beep rate from the speaker and the current reading on the display.

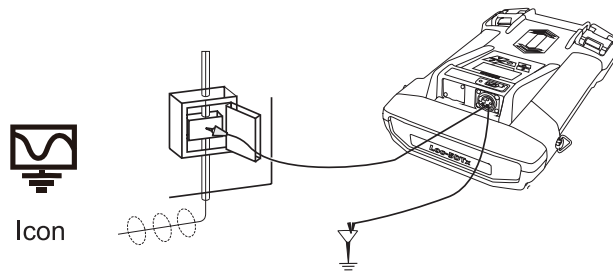

Wherever a direct connection can be safely made without the risk of injury, damage to customer's plant, or the transmitter, it is the best way of applying the transmitter's signal.

The coupling of the transmitted signal to other pipes and cables in the area will be much less than with induction, although where commonly bonded systems are encountered – coupling cannot be avoided.

The positioning of the ground connection can also influence the degree of coupling experienced. Ground connections generally should not be made to other pipes or cables, or above ground metallic structures such as wire fences. In general the lower the frequency is, the further the signal will travel, and the less signal coupling will occur. The most common frequencies used for direct connection are between 512 Hz/640 Hz and 8 kHz.

Regulations in many countries require that power output is limited above certain frequencies. The Loc-5STx enables frequencies below 45 kHz to be transmitted using as much as 5 watts output, but frequencies over 45 kHz are restricted to 1 watt. Using direct connection and the higher power at the low frequencies helps significantly in achieving greater location distances. Direct connections should not be made to cables carrying greater than 25V (or as your safety practices allow). The transmitter is protected (250V fuse) from stray currents that may exist on the target line.

7.3.3 Clamp Mode

Plugging the signal clamp supplied by Vivax-Metrotech into the output socket will place the transmitter in "Clamp" mode. An icon confirming this is displayed on the display. The icon flashes when the transmitter is transmitting. When using the clamp no ground connection is needed.

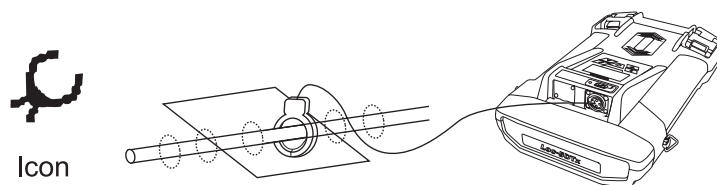

The clamp again is a precise way to apply the locating signal. It is generally used when access to the conductor cannot be achieved to make a direct connection (but there is sufficient access to place the clamp around the cable), or when it is not safe to make a direct connection because the target cable is carrying electricity.

The clamp is a specialized inductive device (sometimes known as a toroid or coupler). All clamps are optimized to work at specific frequencies. In most cases clamps are designed to be used at frequencies generally between 8 kHz and 83 kHz. The transmitter will only allow the selection of a suitable range of frequencies for your clamp.

Note

The clamp works most efficiently if the two halves of the clamp close together correctly. Always check these parts for dirt or excessive corrosion. However, if it is not possible to close the two halves, it may still be possible to locate the line as there will still be a small amount of signal induced into the line.



WARNING

When applying the clamp to cables that carry electricity – be sure to follow your company’s safety instructions and procedures. Beware that if applied around a high voltage cable – that cable may induce a current in the clamp causing it to snap shut or jump quite dramatically – always apply clamps carefully.

7.4 Frequencies

7.4.1 Frequencies and Power Output

The Loc-5STx transmitter is supplied with a predefined set of transmit frequencies. The most commonly used frequencies are preset by the factory. Additional frequencies can be added from the frequency select list. (See section 7.4.2 for access to this menu)

Example of standard frequencies/preset at the factory are:

- 512Hz (where electrical systems are 60Hz) direct connection – 5-watts
- 640Hz (where electrical systems are 50Hz) direct connection – 5-watts
- 8 kHz direct connection – 5-watt
- 33 kHz direct connection – 5-watt
- 65 kHz direct connection – 1-watt
- 83.1 kHz, 131 kHz direct connection – 1-watt (depending on region)
- 200 kHz direct connection – 1 watt (depending on region)
- Some other frequencies with 5-watt output:
 - o Direction connection: 256Hz, 491Hz, 982Hz, etc.
 - o Direct and clamp connection : 8.19 kHz, 8.44 kHz, 9.5 kHz, 9.82 kHz, 32.8 kHz, 38 kHz
- Some other frequencies with 1W output: 89 kHz, 131 kHz, 200 kHz
- Clamp connection: any frequency from 8 kHz up to the highest allowed frequency (depending on region).
- Induction Frequency: this transmitter is a broad-band induction unit. It means that user can select for the Induction mode any frequency he wants, from 8 kHz up. (highest available frequency depends on region).

NOTE: see section 7.4.2 for frequency activation procedure

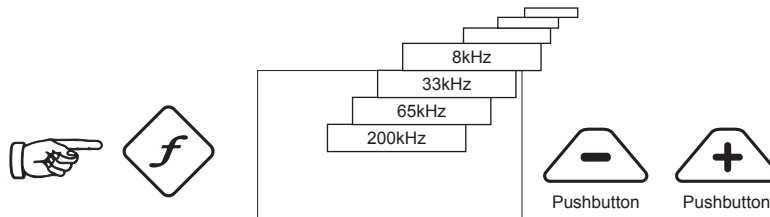

As with most manufacturers the clamps and induction antennas are tuned to specific frequencies, and do not work over the complete range of frequencies.

Frequencies are selected by pressing the “f” pushbutton which toggles through the available frequencies for the selection mode. The frequency is automatically selected if you don’t toggle past it within two seconds. The frequency is shown on the display.

NOTE:

The output current is shown in large characters on the display – to increase or reduce the power output press “+” or “-”. The vertical bar graph at the bottom of the display indicates which of the five current output steps is being used. If the transmitter can supply the requested current, the bar will turn black. If the bar does not turn black, improving the ground connections or wetting the ground where the earth stake is positioned, may help. However, it may not be able to achieve the current setting requested because the impedance of the line is too high for this setting. If this happens it is best to select a setting that has a black bar, this will ensure a stable output.

The current being transmitted will be limited by the impedance of the cable, therefore it is not unusual to increase the output level, but see no increase in the current displayed. This is not a fault with the transmitter.

The transmitter will always revert to first level output when switched on – this is a power saving feature – in most circumstances this output level is sufficient. Increasing the output power unnecessarily will reduce the battery life unnecessarily. All other settings remain the same as the last setting used.

7.4.2 Most Used Frequencies (Frequency Selection) Feature

This feature can be used to allow operator to choose his most used frequencies from a list of possible frequencies. Once these frequencies are selected in the main menu, pressing the "f" pushbutton, user can scroll through them. At any time user can add or remove frequencies from the above list, following the below procedure. Maximum frequencies that can appear in most used frequencies list is 12.

The advantage of this feature is that user can optimize the transmitter and activate at the main menu user's preferred frequencies, instead of having a whole list of frequencies that user has to scroll through.

To enter the "Frequency Menu" proceeds as follows:

1. Press the "i" pushbutton four--six times (based on the mode that transmitter is in), until get to the "Frequency menu" sub-menu.

In Direct Connection mode,

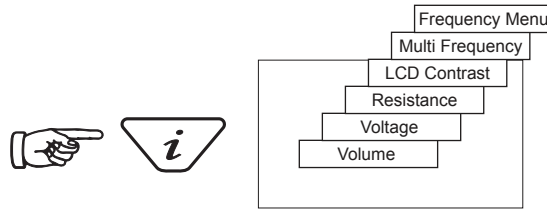

In SD mode,

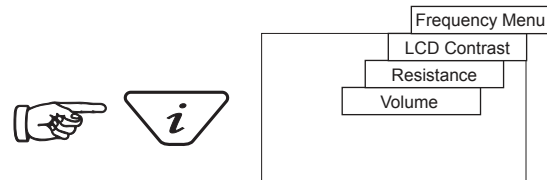

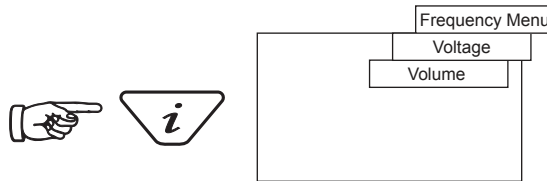

In Clamp mode,

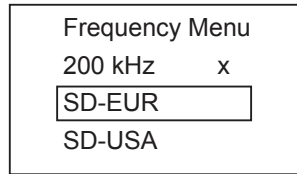

7 Loc-5STx Transmitter

2. Screen will show a list of frequencies available, with the central one in a box.



3. Pressing the " " or " " pushbuttons, you can scroll up or down through the available frequencies.
4. Once the wanted frequency is inside the box, press "f" pushbutton to select or deselect the frequency. An "x" will appear in the box for a selected frequency.

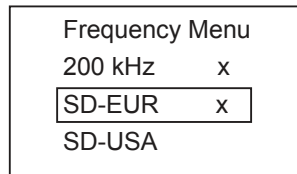

5. After selecting the frequencies, press the "i" pushbutton again to exit the "Frequency Menu" and return to the main display.
6. A particular frequency in the chosen list of frequencies can be selected from the main display screen by pressing the "f" pushbutton until the wanted frequency is displayed at the top of the main screen.

7.4.3 Multi Frequency Mode for Direct Connection

This feature can be used when user wants to energize on target two/three frequencies at the same time. Mainly, it can be used when user is not sure which frequency can be impressed better into the target. Multi frequency mode is not available in Fault Find and SD modes.





NOTE

When using multi frequency mode, total power will be split between the activated frequencies.
The frequencies have to be available in the main menu.

To enter the "Multi Freq. Setup" menu, proceeds as follows:

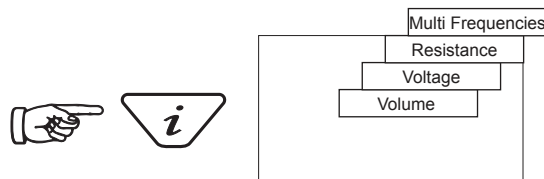
1. Press "i" pushbutton four times to get to the "Multi Frequency" screen and press "f" pushbutton to activate the multi frequency mode. An "x" symbol will appear indicate the multi frequency mode is activated. Press "f" pushbutton again to go in "Multi Freq. Setup" screen to choose the frequencies.



2. Press the " " or " " pushbuttons to scroll through the available frequencies and bring the wanted one in the first box.

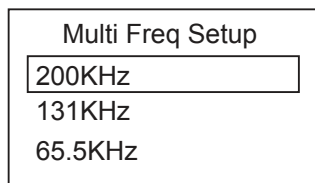

7 Loc-5STx Transmitter

- Press "f" pushbutton to move the box down and the "+" or "-" pushbuttons to select the second frequency.

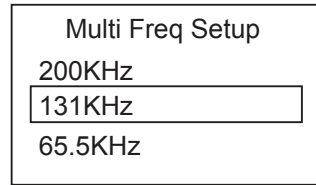

- Repeat step three to select the third frequency if needed.
- Press "i" pushbutton to return to main display. On the main display, "Multi" will appear indicating the multi frequency mode is active.

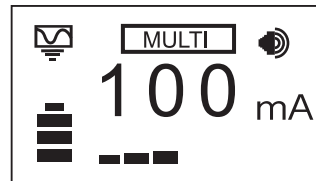

- The frequencies selected for multi frequency mode will be saved until changes are made even when the multi frequency mode is deactivated.

7.5 Transmitter Battery

7.5.1 Replacing Alkaline Batteries

- Replace with new batteries of the same type, be sure not to mix old and new batteries.
- Do not** use rechargeable batteries in the alkaline battery tray. Ensure that batteries are inserted the correct way (see label "+" and "-" on the side of the tray).
- Refit the battery tray, place it inside the housing and close the battery cover.



WARNING
Alkaline Batteries – insert alkaline batteries (x8) as shown.

7.5.2 Rechargeable Batteries

- Do not** attempt to replace the rechargeable batteries or remove battery covers – return to Vivax-Metrotech or a Vivax-Metrotech approved service centers for replacement.



WARNING
Use only Vivax-Metrotech recommended charger.



WARNING
Charging socket

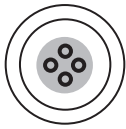

Two pins are used for power in from charger (to charge rechargeable batteries).



NOTE

Rechargeable pack cannot be charged from a 12V DC source.

Contact Vivax-Metrotech or a Vivax-Metrotech approved service center for wiring diagram of plug, if attempting to repair any of the “charging” leads.

7.5.3 Battery Charging and Disposal

Follow instructions detailed in the General Safety & Care portion of this document.

Only use the charger supplied with the equipment. Using a non-approved battery charger may damage the batteries and cause overheating.

The charger is mains operated. Connect the charger to the battery pack at the rear of the transmitter. The LED on the charger will show a red light indicating that the charge process has started. When the LED changes to a green indicator the charge sequence is complete and the batteries will be fully charged.

7.6 Induction Mode

Uses an internal antenna to induce a locating frequency onto the target pipe or cable (line). “Induction” mode is automatically selected if no connection accessories are plugged into the “output socket”. In order to generate successful induction, the transmitter should be positioned over, and in line with the target line.

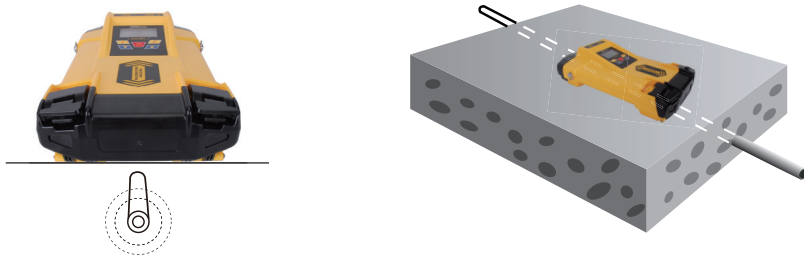

“Induction” mode is generally used when no access is available to make a direct connection, or a clamp connection. When using induction it is very likely that the signal being induced onto the target line will also be induced onto other lines in the area, and onto above ground features such as wire fences. This can influence the accuracy of the location, depth and current measurements. “Induction” mode is also the least efficient way of applying the transmitting signal to the target line. The distance located with “Induction” mode is generally much less than that achieved with a direct connection or clamp connection. “Induction” mode generally works better in higher frequencies, usually 33 kHz up to 200kHz (depending on region). The advantage of induction is that no access is required to “connect” the transmitter, making it a very quick process. The antennas on the transmitter are tuned to induce specific frequencies or range of frequencies. Therefore only a limited number of frequencies can be selected in “Induction” mode.



NOTE

For accurate location and depth measurement the locator receiver should not be used within 50ft (15m) from the transmitter.

7.7 Direct Connection Mode

A connection lead set is supplied with the Loc-5STx transmitter. The connection lead is used to make an electrical connection to a cable or pipe that is to be traced. One of the leads is connected to the line and the other to a ground point that is nearby or by inserting the ground rod supplied with the equipment into the ground and connecting to that.

A good connection is indicated by a change in beep rate from the speaker and the current reading on the display.

More information can be found in section 7.3.2.

7.8 Clamp Mode

The signal clamp is an optional extra. There are three different sizes 2in (50mm), 4in (100mm), 5in (125mm).

The clamp is generally used to apply the signal tone to a live cable or telecom cable where an electrical connection is not possible because of safety or access issues.

Please refer to section 7.3.3 for further information.



8. Loc-1Tx Transmitter

8.1 Pushbuttons

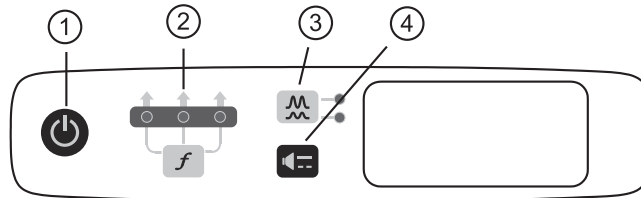

1	On/Off Control
2	Frequency Select (the arrow points to the corresponding frequency printed on the label on top)
3	Output High/Low setting
4	Audio Beeper Level

8.2 External Connectors

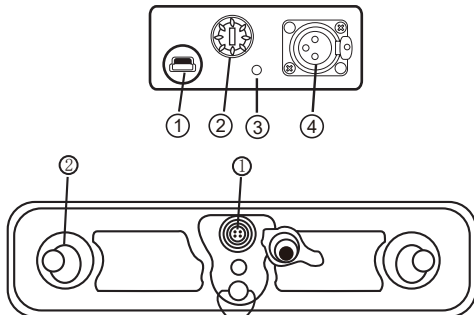

1	Mini USB Port
2	Output Fuse
3	Speaker
4	Output Connection

1	DC Input (power supply only)
2	1/4 turn fasteners

8.3 Replacing Alkaline Batteries

- To remove the tray, operate the three 1/4 turn fasteners in a counter-clockwise direction. This should now release the tray which can then be slid out from the transmitter body. Be careful not to allow the batteries to fall from the tray as it is removed from the body.
- Replace with new batteries of the same type, be sure not to mix old and new batteries
- Do not use rechargeable batteries in the alkaline battery tray. Ensure that batteries are inserted the correct way (see label “+” and “-” on the side of the tray)
- Refit the battery tray and operate the three 1/4 turn fasteners in a clockwise direction



WARNING
Alkaline Batteries – insert alkaline batteries (x4) as shown



8.4 Rechargeable Batteries

Rechargeable batteries are not available for the Loc-1Tx transmitter.

8.5 Loc-1Tx Transmitter Operation

The operation of the Loc-1Tx transmitter is very similar to the Loc-5STx transmitter. This is covered in section 7.7 to 7.9.

9. Using the vLocPro2

9.1 Using the Receiver

9.1.1 Line Locating

Line locating is when a pipe or cable is being located. When line locating, the receiver should be held with the display forward, and then sweep to the left and right across the suspected direction of the buried line. Note the compass (line direction indicator) always points in the direction of the line (active in active modes). The compass (line direction indicator) color change from clear to blue when the receiver is in line with the buried line.

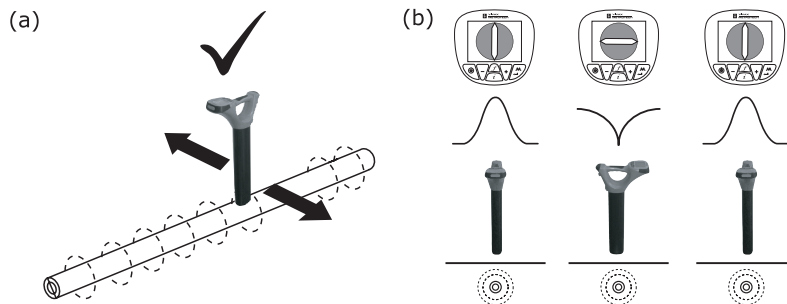

The receiver should be kept parallel to the ground – and should not be flipped up at the end of each pass. See diagram (a).

To establish the direction of the cable – use whatever mode you prefer to locate the line; then switch to “Peak” mode to confirm the direction. Pinpoint the line – by carefully establishing the exact “Peak” position. Then (with the base of the receiver on the ground), rotate the receiver 90 degrees. As you do this the signal being received will reduce substantially (possibly disappear). Then rotate the locator until you find the maximum “Peak”. The front of the locator is again facing in the direction of the buried line. See diagram (b).

9.1.2 Depth & Current Measurement

Pinpoint the exact position of the cables as follows:

- Locate lateral position of the cable.
- Rotate receiver to confirm the direction of the cable (you will see a null response when the receiver is intersecting the direction of the cable at 90 degrees).
- Rotate the receiver back until it is exactly in line with the cable.

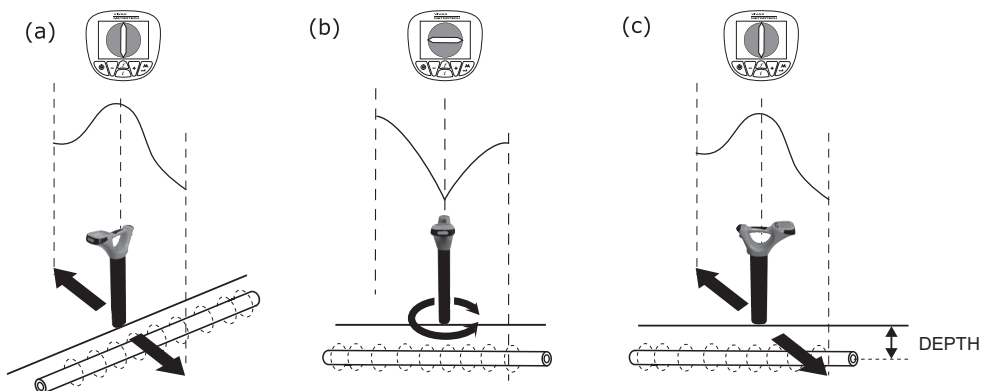

9 Using the vLocPro2

- Once the position and direction of the cable has been established, stand with the base of the locator on the ground – with the locator in the absolute “Peak” position (over and in line). Then press the “i” information pushbutton briefly, the current and depth will be displayed.

9.1.3 Sonde Location

This is used for locating a Sonde only. A Sonde is a transmitting coil and the signal radiates in a different manner than that of a line (see diagram b).

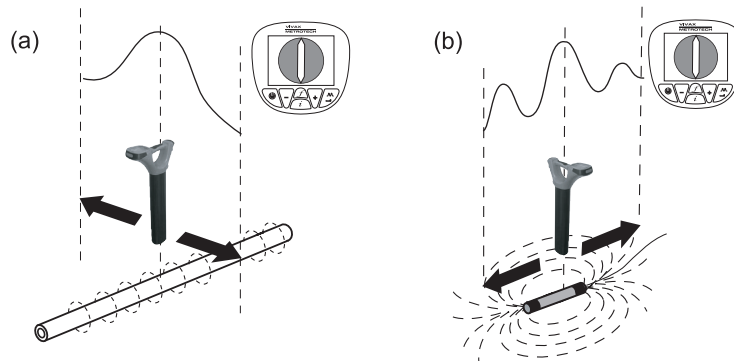

Due to this construction, the Sonde gives a different “Peak” pattern (see diagram b) – note that there are three distinct peaks – a small peak – a large peak – a small peak. The Sonde is located under the center of the “large peak”, when locating across the direction of the Sonde it provides the conventional peak response. Note also that the compass (line direction indicator) points across the line of the Sonde when the receiver is directly over it and the color of the compass (line direction indicator) change from clear to blue.

A Sonde is typically used for locating nonmetallic pipes or ducts, and the camera end of a sewer inspection camera. Low frequency versions (512Hz/640Hz) can transmit through some metallic pipes such as cast iron pipes – which is why they are frequently used with sewer inspection cameras.

The procedure for Depth Measurement is the same as in line location, but must be done in the Sonde mode. Depth measurements taken from a Sonde in any mode other than Sonde mode will be inaccurate.

9.1.4 Using the Compass (line direction indicator) Feature to Locate Sondes

Switch on the vLocCam. Select the frequency to match the Sonde frequency. Use the mode pushbutton to select Sonde.

Stand in the approximate vicinity of the Sonde. Press the “+” pushbutton to increase the gain so that a steady bar graph reading is displayed. If no bar graph, or a fluctuating bar graph is shown, it means that the Sonde is not in the expected vicinity. If this is the case pull back the Sonde to a known position, which may be the point the Sonde enters the pipe, and start the search here.

Rotate the locator until the compass (line direction indicator) is pointing at 12 o'clock. Walk in the direction of the compass (line direction indicator) keeping the compass (line direction indicator) pointing at 12 o'clock. The locator will lead you in an arc that crosses over the Sonde. Press the gain pushbuttons to keep the bar graph on scale. The maximum bar graph indicates the position of the Sonde.



To pinpoint the Sonde, find the peak in both directions.

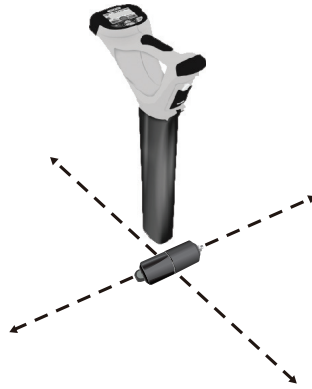

When over the peak position, the depth is automatically displayed. Press the “i” pushbutton to get a more precise depth reading.

TIP

- Using the compass (line direction indicator) to locate the Sonde requires free space to walk to the side of the Sonde. If there is an obstacle such as a wall or vehicle that restricts walking in an arc, the following method can be used.
- Position the locator in the approximate vicinity of the Sonde as above.
- Rotate the locator so that the compass (line direction indicator) is now pointing at 3 o'clock.
- Now step to the side keeping the locator pointing in the same direction. The compass (line direction indicator) will rotate slightly.
- Keeps the locator pointing in the same direction and walk forward. The compass (line direction indicator) will slowly rotate. When it reaches 12 o'clock follow the compass (line direction indicator) keeping it at 12 o'clock.



Pinpoint the Sonde as in the first procedure.

9.2 Passive or Active Location

There are two types of location methods available with this system, they are:

9.2.1 Passive Locating

Passive locating is locating buried utilities using the electromagnetic signals that exist in the environment. We group these under two settings:

- Power (P) – these are signals that generally originate from electrical power generation systems. These are around 50/60 Hz and their associated harmonic.
- Radio (R) – these are signals that are generally originated by low frequency radio transmissions. These are generally in the range of 16 kHz to 22 kHz.

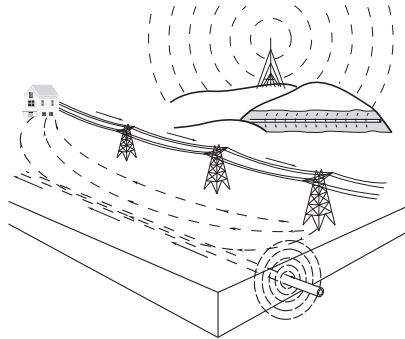

Passive location is used to search an area to see if buried metallic lines are present (known as locating to AVOID). It does not help to identify what buried pipe or cable is present, only to confirm that there is a pipe or cable there. A typical application would be to check an area before installing a fence post.

9.2.2 Active Locating

Active locating is using a transmitter to apply a very precise frequency to a pipe or cable, and then using a receiver turned to find the signal being radiated at that precise frequency. Active location frequencies can be applied by direct connection, clamp or induction.

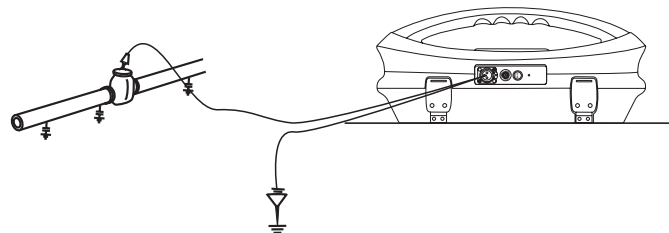

This receiver provides a wide range of frequencies for active location. Some will be the same as the frequencies provided by the Vivax-Metrotech's transmitter, others will be frequencies used in other manufacturers' transmitter.

The choice of frequencies when using induction or the clamp is restricted due to the requirement that these modes be tuned for specific frequencies (or range of frequencies). The full range of frequencies is available in "Direct connection" mode.

For frequencies below 45 kHz, authorities such as the FCC allow higher power output to be used; for frequencies of 45 kHz and above, power output for this type of equipment is restricted to 1 watt. Therefore more power is available when lower frequencies are used.

9.3 Applying the Transmitter's Signal

The transmitter's signal cable is applied in any one of the three ways:

9.3.1 Direct Connection

This is used on pipes or cables that are not live and do not carry hazardous voltages. The "Direct connection" mode will be selected automatically when the connection leads are plugged into the transmitter.

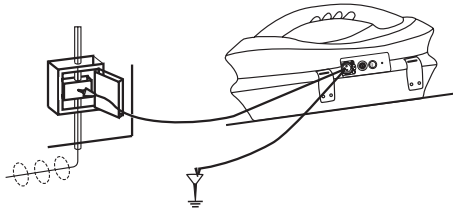

WARNING
Never make a direct connection to live cables carrying hazardous voltages.

Do not plug the connection leads into the transmitter before connecting to the buried line and fixing the ground stake.

Take the ground stake and push firmly into the ground and connect it to the black connection lead.

To make the signal travel further along the buried line, ensure to place the ground stake as far away as possible, and at 90 degrees to the line. Where practical avoid having other buried lines between the ground stake and the target line, this will reduce the chances of the transmitter signal coupling to another pipe or cable.

Do not connect the black lead to any other metallic items that may have an above or below ground structure, or to any other pipes or cables; connecting to such items would cause signals to radiate from these secondary structures, which in turn will increase the likelihood of an incorrect locate.

Connect the red connection lead to the target line after removing any surface corrosion.

Plug the connection leads into the transmitter, switch it on and select the desired frequency.



WARNING
Be careful! not to hit other buried lines when inserting the ground stake into the ground. Check using passive location prior to inserting ground stake. Stop if additional resistance is felt during insertion.

9.3.2 Clamp (Coupler)

This is used when applying the transmitter signal to cables carrying hazardous voltages, or cables where access to the metallic conductor is not possible, or desirable. The "Clamp" mode is selected automatically when the clamp is plugged into the transmitter.

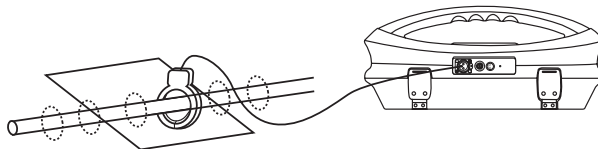

For a clamp to work, the current induced by the clamp must flow along the buried line. This means the buried line must have a ground connection at both ends.

Plug the clamp into the transmitter before applying it to the target line. Open the jaws of the clamp, place around the target line, close the jaws. Be sure that the jaws of the clamp are completely closed. After applying the clamp, switch on and select the required frequency. Clamps are generally turned to specific frequencies. Your transmitter only allows frequencies that are compatible with the clamp to be selected.

Note

The clamp works most efficiently if the two halves of the clamp close together correctly. Always check these parts for dirt or excessive corrosion. However, if it is not possible to close the two halves, it may still be possible to locate the line as there will still be a small amount of signal induced into the line.

WARNING

Always follow the appropriate safety requirements mandated by safety legislation, safety practice or your company's safety procedures when applying a clamp (coupler) to a cable.



Beware that when placing a clamp around cables carrying high current, the clamp may vibrate, jump or close violently due to inducted current from the target cable.

Also, in particular situations higher voltages can be induced in the clamp and be present at clamp's plug, from lines carrying currents. Safety practices should be followed all the time when clamping around live target lines!

9.3.3 Induction

This is used when no connection via direct connection leads, or coupler is possible. If no connection leads or clamp are connected to the transmitter, it will automatically select "Induction" mode.

An induction loop is fitted inside the handle of the transmitter. The transmitter must be placed over the target cable with the handle over and in line with the target pipe or cable. The induction loop is tuned to operate at specific frequencies. Only these frequencies can be selected when in "Induction" mode.

Do not place the transmitter on a manhole cover, or any other such metallic object, as that object will shield or soak up the signal resulting in little or no signal being induced in the target line.

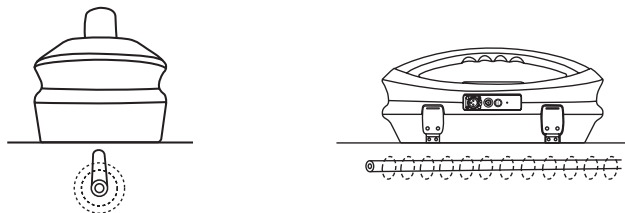

When using the "Induction" mode to apply a signal to a line, ensure that a minimum distance of 50ft (15m) is maintained. This is because the transmitter will transmit signal through the air which will interfere with signals from the cable, resulting in incorrect information.

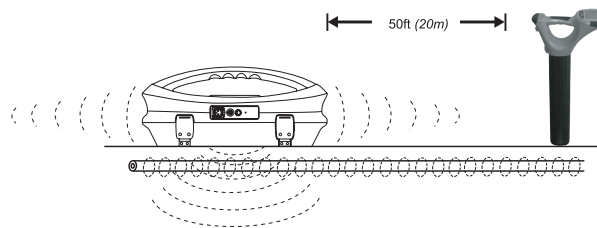

**NOTE**

For the proper orientation when using the Loc-5STx or Loc-1Tx transmitters in **INDUCTION mode**, please check section 7.6 and 8.

9.4 Searching (sweeping) an Area

In any given area, it is likely that buried pipes and cables are not parallel to each other, frequently they will cross the area being searched at a variety of different angles and depths. As the response of locator antennas is directional, it is important to search the area in the same or similar pattern as below. This orients the antennas in a way that will locate any signals being radiate from the buried line. Once a response is found, then trace and pinpoint the line and mark. Searching an area in this way is generally (but not exclusively) done in the "Peak" mode using passive locating.

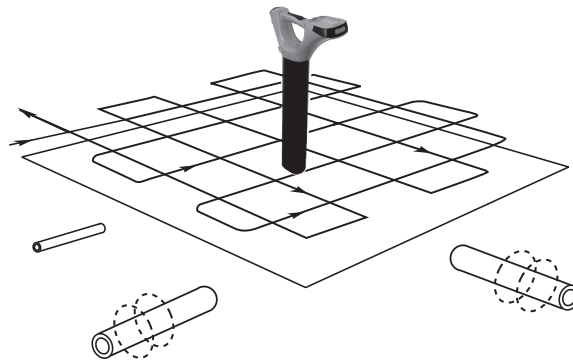

9.5 Tracing a Buried Line

Once a buried line is located it is generally necessary, and a good practice, to trace that line for some distance in both directions. Whenever practical it should be traced to a point that provides additional confirmation of what type of service is being located (a telephone pedestal, a manhole cover etc). If tracing a line to which a transmitter signal has been applied, one should trace out from the transmitter connection point. The receiver should be held level to the ground and rotated in a small arc across the anticipated route of the buried line. A clear response should be visible on the display and heard audibly.

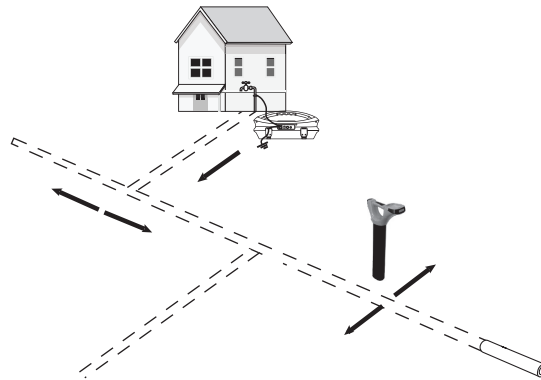

9.5.1 Pinpointing & Confirming the Buried Line

Marking the exact position of the buried line is generally called pinpointing. Pinpoint the line before marking its position. Place the receiver in "Peak" or "Left/Right" mode, pass the blade of the receiver across path of the cable and identify the peak response on the display and/or audibly.

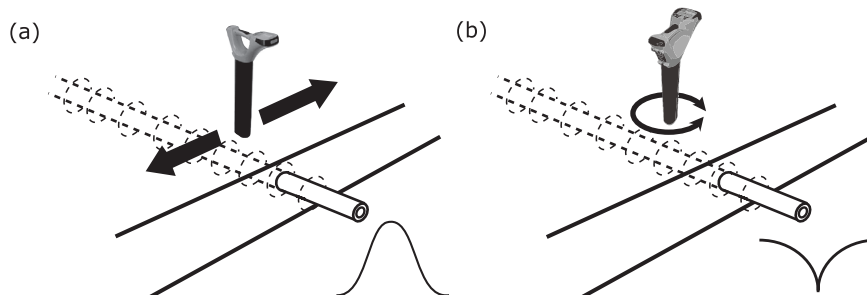

9.5.2 Distorted Fields

When locating, always be aware that you are locating the signals radiating from the buried line, and these radiated fields, as they are called, can be distorted by other lines or electromagnetic buried lines or metallic features like crash barriers or wire mesh fences. The risk of an inaccurate location can be reduced further by the following:

- Check to see if the signal is being distorted by other radiated fields. Locate the cable, first in the “Peak” mode, and then in the “Null” mode. The two locations should indicate that the cable is in the same place. If they do not, the signal field is distorted and the depth and current measurement may be inaccurate.

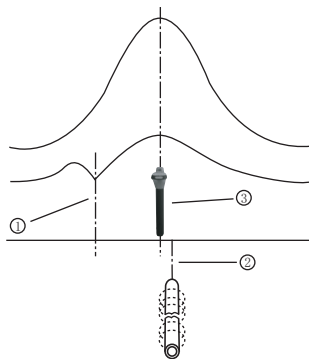

1	Null Position
2	True Position
3	Peak Position

- Measure the depth of the buried line by pressing “i” pushbutton briefly to measure depth and current. The depth should be approximately in line with the “as built” plans available. If no plans are available logic would still help to assess the situation (if you are looking for a CCTV distribution cable and the depth indicated is 5ft (1.5m) it is probably not your cable). Current will be displayed at the same time as the depth.
- A depth reading on congested areas or close to bends or tee’s maybe inaccurate due to distorted fields.



Note:

One other source of apparent distortion is signal overload.

In the unlikely event a screen is shown as below, i.e. an explanation mark within the compass bezel, this indicates that the signal being received by the locator is too strong to be processed accurately. In this instance any information received from the locator should be treated with caution.

9.6 Measuring Depth and Current

- Pinpoint the cable as described in "Pinpointing cable", with the receiver in line with and directly above the buried line – measure the depth (d) by pressing "i" pushbutton briefly. Current will be displayed at the same time as the depth.
- Be careful when locating in congested areas or close to bends or tee's, they may be inaccurate due to distorted fields.

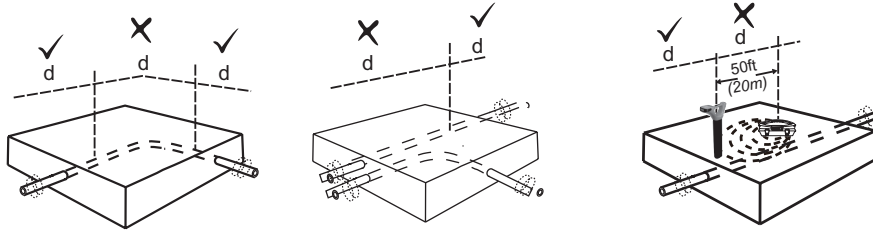

- An alternate method of verifying depth (D) is triangulation. There are two methods of triangulation, 50% and 70% rules. If using the 50% rule Broad peak mode (single antenna) should be used or peak mode if using the 70% rule. On some models there is an option that instructs the user in taking triangulation measurements. In this case the antenna selection is done automatically so the operator does not need to select the antenna configuration.

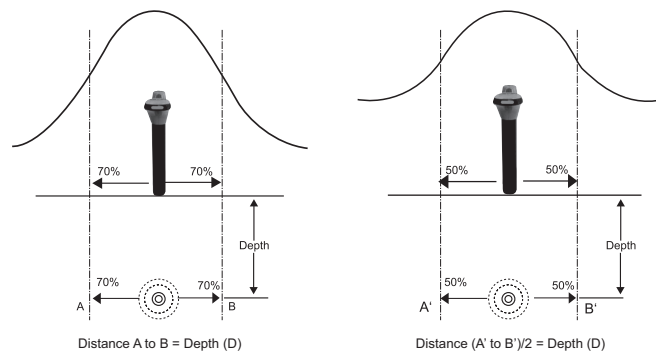

Semi-Automatic Triangulation Mode

On some models a "triangulation mode" is available that assist in taking these types of measurements.

To use the Triangulation mode the function must first be activated in the User Menu. The User Menu will give the option of Peak Depth or Triangulation. If Triangulation is selected, either 50% or 70% rules will be initiated. 50% or 70% rules are selected by connecting the unit to MyLocator2 and selecting "Menu Settings" and then the desired rule in the "Depth Mode" tab.

To use the function first locate the cable or pipe in the usual way.

Press the "i" pushbutton and a depth will be indicated. To confirm with triangulation, press the "i" pushbutton again.

The following screen should be shown.

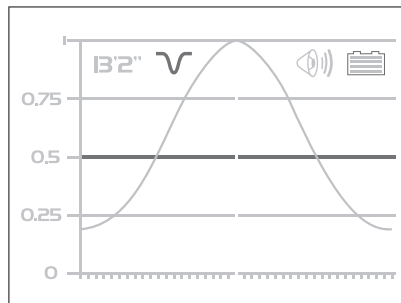

Now slowly move the locator to the side until the line on the graph reaches the 50% line. (or 70% if the 70% rule is used). At this point an audible beep will confirm this position is reached. Mark the ground at this point and then slowly return to the peak position. Continue past this position until the 50% mark is reached on the other side. Mark this position.

Now measure the distance between these two points. Divide the distance by two. The result will indicate the depth of the target line.

If the 70% rule is used, do not divide by two, the depth is equal to the distance between the points.

Measure the current. This is displayed when you briefly press the “i” pushbutton to measure depth. The signal from the transmitter will attenuate with distance. The further you are away from the transmitter the less signal will radiate from the buried line. By locating at several points along the buried line you will identify an approximate rate of signal loss (beware that where a pipe or cable divides the signal will reduce more rapidly). If the signal at the point you are pinpointing is different from the trend would suggest – between that, it may not be the buried line you expect.



WARNING

Never mechanically dig over the path of a buried pipe or cable. ALWAYS dig carefully.

9.7 Signal Direction Precision Identification

(Available for vLocPro2-SD and vLocML2+ models only)

Some models in the vLoc series of locators contain a feature called “SIGNAL DIRECTION”. This feature is used to verify if the line being located is the target to which the transmitter has been connected.

When a transmitter is connected to a target line, the signal travels along it and finds the easiest way to travel back, usually via the ground and ground stake. However, very often the signal will travel back along adjacent cables or pipes as these can offer an easier route.

As a result, there can be multiple signals radiating from cables and pipes in the area making it difficult to identify the target line. These return signals are typically traveling in the opposite direction than the applied signal. The Signal Direction feature identifies which direction the signal is flowing and hence the target line.

To use the signal direction system:

- Connect the transmitter to the target line using a direct connection only.

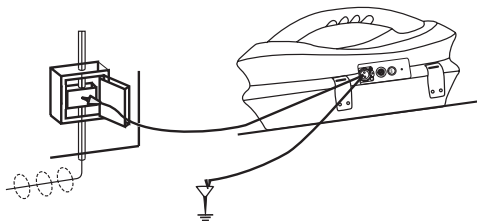

- Turn the transmitter and receiver on, and set both to:
 - o SD-USA – if in North America or any territory where the power system is 60Hz.
 - o SD-EUR – if in Europe or any territory where the power system is 50Hz.
- The receiver may or may not be flashing the “SD” icon and compass (line direction indicator) bezel. “A flashing icon and bezel indicates that the unit needs to be synchronized with the transmitter.” Even if the icon is not flashing it is always good practice to synchronize the system at the beginning of a survey to ensure reliable results and to maximize the distance to the next synchronization point.

9 Using the vLocPro2

- To synchronize the receiver to the transmitter at the beginning of a survey, pinpoint the line very close to the transmitter – be sure that it is the correct line. Then, standing facing away from where the transmitter is attached and press the “i” pushbutton. The unit will now display the information screen showing the depth of line, signal current and a hand with the “SD” icon positioned over the return pushbutton. Pressing the return pushbutton will synchronize the system and return the unit to the locate screen. The top portion of the bezel surrounding the compass (line direction indicator) will light and not be flashing indicating the receiver is locked onto the signal. The system is now synchronized.

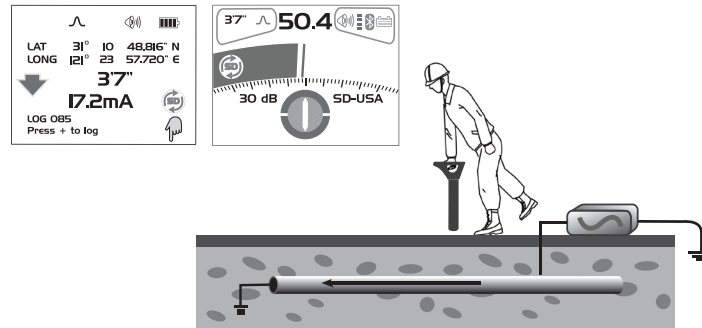

- Proceed to locate, trace, pinpoint as required ensuring at all times the top portion of the compass (line direction indicator) bezel remains illuminated.
- If at any time top portion of the bezel ceases to be illuminated and the bottom portion of the compass (line direction indicator) bezel lights up – you are not locating the correct line, you are locating a line which is carrying the return signal.

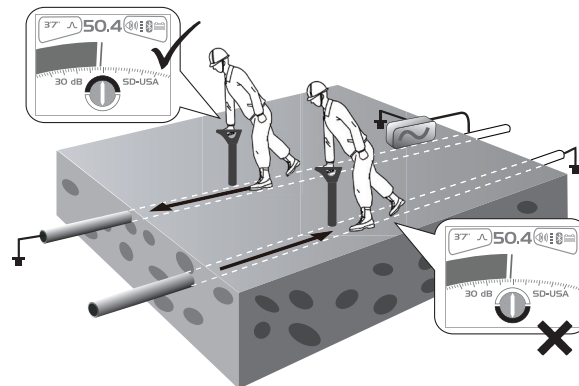

- At some point you may find that the top or bottom portion of the compass (line direction indicator) bezel together with the SD icon and start flashing – this is indicating that synchronization with the transmitter has deteriorated and a reset is required.

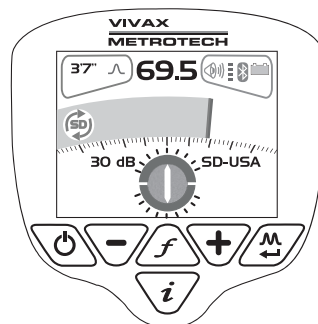

9 Using the vLocPro2

- Re-trace your line back to a point where a solid signal direction is obtained. Precisely pinpoint the line and stand with your back to the direction of the transmitter as you did when you initiated the original sync and press the “i” pushbutton then the enter/return pushbutton to re-sync with the transmitter signal.

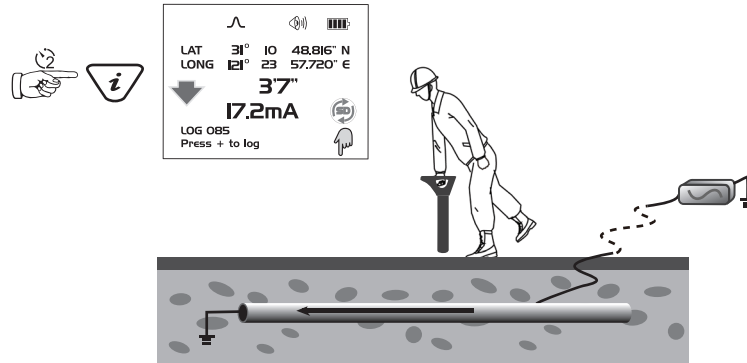

- Continue to locate, pinpoint and trace.



NOTE

If several lines are commonly bonded the Signal Direction will carry through to the other lines. This is useful for locating multiple line installations.

However, be aware that if a non-target line is commonly bonded to the target line that line will also appear as being “in Sync” with the target line.

When performing a reset, take care to ensure that you have not strayed from the target line.

9.8 Using the Accessories

9.8.1 Using the LPC Separation Filter



The LPC separation filter (LPC) is used to safely inject a trace tone to a live cable via a domestic mains socket, so that the cable can be traced from the premises to the connection in the street. It is suitable for connecting to voltages between 100V AC and 250V AC.

Method:

Plug the LPC into the output socket of the transmitter. Identify a suitable main socket. If a switch is fitted to the socket, switch off. Plug in the LPC to the mains socket and then switch back on. Set the LPC rotary switch to match the two indicator lights. Set the transmitter to the frequency to be located.(8 kHz or 32 kHz are good frequencies for this application). Set the output to mid-range.

9.8.2 Using the Analogue A-frame in Fault Finding

NOTE

Fault finding requires a non standard signal. Historically there have been many versions of fault find signal. Some of these are listed below:

- 3/6Hz Fault Find (used to detect faults on pipelines)

9 Using the vLocPro2

- Signal Select Fault Find (good for fault finding on short runs such as power networks)
- SD Fault Find (general purpose fault finding)
- 8kHz FF (general purpose fault find with good results on short and long runs and has good sensitivity)

For the purposes of this manual, 8kHz FF is concentrated on as it gives the best overall performance.

Also note that 8kHz FF is only compatible with the latest analogue A-frame which can be identified by the six pin socket on the A-frame. This was introduced late in 2015. (previously was four pin)



The A-frame accessory is used to detect ground faults on pipes and cables. In the case of pipes, the faults consist of coating defects. In the case of cables, faults are usually caused by insulation damage allowing the metallic sheath (or internal conductor) to become in contact with the ground.

To detect a damaged section, the line should be isolated and have all ground bonding removed. This will ensure that the ground fault is not masked by deliberate bonding to ground. The A-frame cannot distinguish between these two situations.

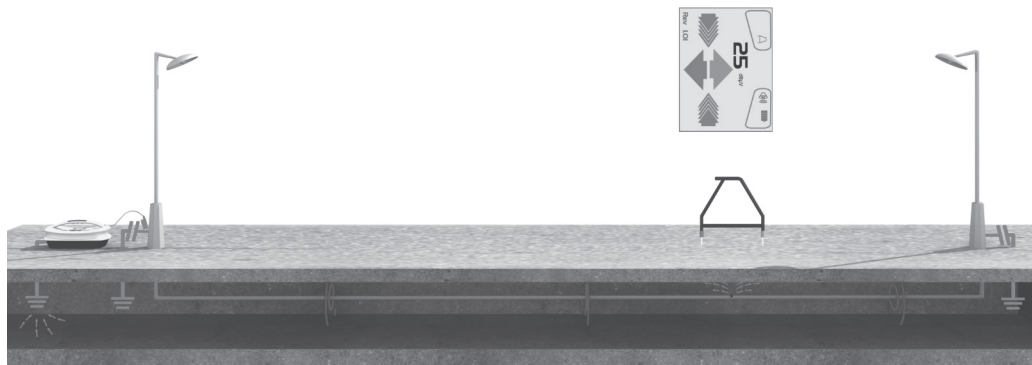

After isolating the line, use the vLocPro2 transmitter resistance measuring function, or a dedicated resistance measuring device to confirm that there is a fault to ground. The A-frame will typically detect faults up to two Mohm and above (depending on the distance from transmitter, soil conditions etc).

Connect the transmitter to the target line using the red lead. A ground stake needs to be pushed into the ground and the black cable clipped to it. Try to place the ground stake as far as possible from the line to be evaluated. This ensures return currents **do not** distort the results. Switch on the transmitter and select either 8kFF low or 8kFF high. Use 8kFF high if the line to be surveyed is long or the fault resistance is high. Make sure the receiver and transmitter are set for the same FF type, ie 8kFF.

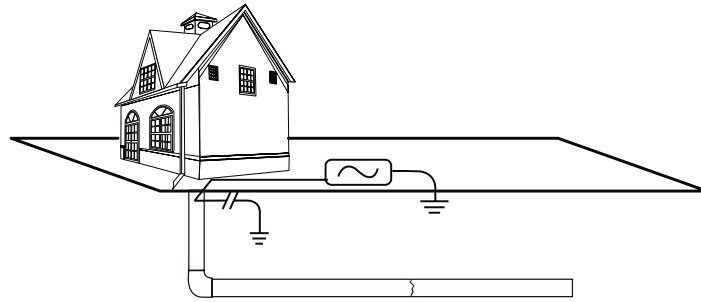

Plug in the A-frame to the receiver accessory socket. When the receiver is switched on, it will automatically default to the A-frame screen.

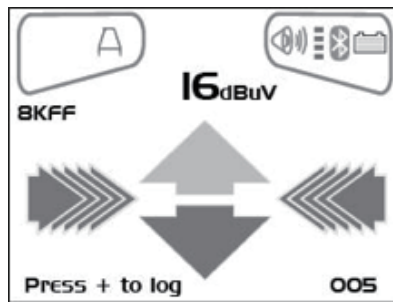
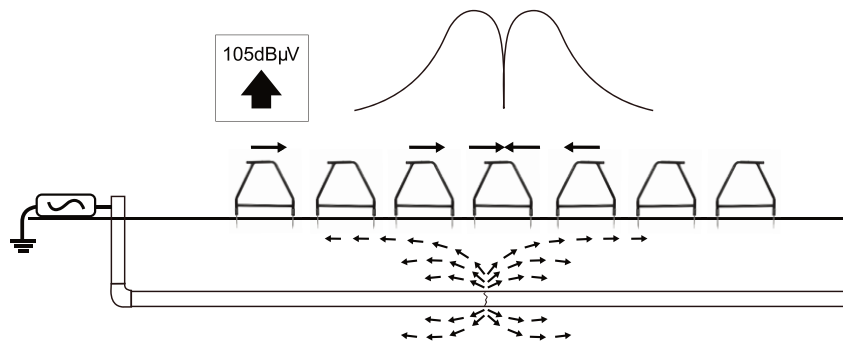
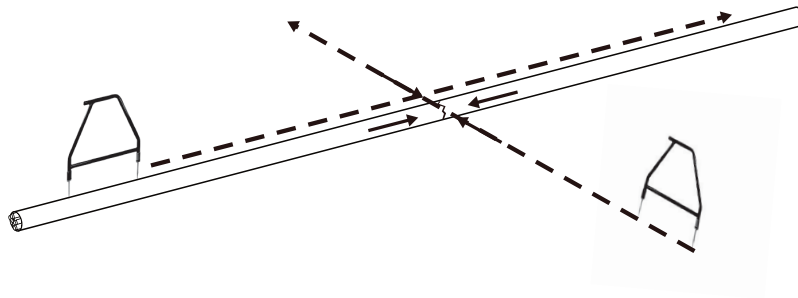

Image for reference only and may differ from actual image

Remove the plastic spike covers from the A-frame. Walk along the route of the line placing the spikes of the A-frame in the ground (with the green leg pointing away from the transmitter connection point) every two or three paces. If starting near the transmitter, the arrow on the display will point away from the ground point. As the distance from the transmitter increases, the dBuV reading will reduce and eventually the arrow will fluctuate or disappear altogether. This is because the fault location is further along the line. Use the left/right arrows to ensure the A-frame is positioned over the line and continue placing the A-frame in the ground every two or three paces. If necessary, use the "M" pushbutton to enter the locate screen allowing the user to confirm the position of the target line. Press the "M" pushbutton again to re-enter the A-frame mode.



Eventually the A-frame will detect the fault signal and the "Fault Find" arrow will point forwards. Continue moving forwards, it may be worth reducing the distance between measurements points as the fault is neared. The dBuV reading will increase as the fault is neared. Maximum reading will be just before and just after the fault. When over the fault, the dBuV reading will drop and the arrow will flip backwards indicating that the position of the fault has been passed. Carefully place the A-frame before and after the fault to pinpoint the position. Repeating this across the line direction will pinpoint the fault laterally. The fault will be at the point where the lateral fault is identified.



WARNING

Always disconnect or isolate target/faulty/suspected cables before connecting the transmitter to it. Never attach the transmitter to live cables.



TIP

If it is suspected that there is just one fault, insert the A-frame approximately one meter from the earth stake. Note the dBuV - this is approximately the maximum dBuV reading that will be measured over the fault.

9.8.3 Using the Analogue Remote Antenna



The remote stethoscope antenna can be used to help identify a particular cable on a cable tray or where cables are bunched together.

Methods:

1. Connect a signal to the cable to be identified. The remote stethoscope functions have an operational frequency range of 512Hz up to 200 kHz, but low frequencies should be a preference in this application as they are less likely to leak or bleed over to other cables.
2. The best method of signal application when identifying cables is to use the signal clamp. This is because the signal clamp applies a signal to the target cable and shares an equal amount with other cross bonded cables.

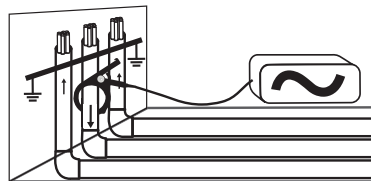

3. When using the signal clamp, both ends of the target cable should be grounded. Apply the clamp below the ground point. Applying the clamp above the ground point will prevent the signal finding the return path through the ground, so is not advised.

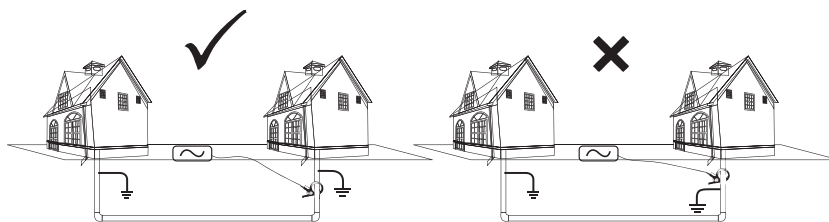

9 Using the vLocPro2

- If this is not possible to use a transmitter signal clamp, and you have confirmation that the cable is out of service, use a direct connection lead to make an electrical connection to the cable. Removing any cross bonding between cables prevents the signal to travel along commonly bonded cables.

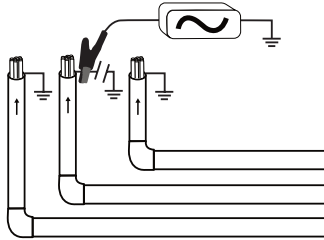

- Do not** use the Induction method as the signal will appear on all cables in the area of the transmitter.
- Connect the remote stethoscope antenna to the accessory input of the receiver. The correct settings and user interface will be automatically selected.

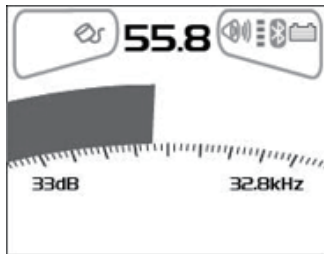

- Ensure the frequency selected on the vLoc is the same as selected on the transmitter.
- Place the stethoscope on each of the suspected target cables with the flats of the antenna in line with the route of the cable.

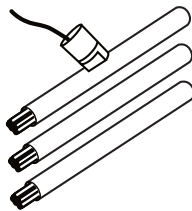

- The one with the largest reading is likely to be the target cable.
- If necessary, adjust the sensitivity of the vLoc so that the signal is within the operating section of the bar graph. This will help identify the cable if the signal levels are similar because of cross coupling of the signal.



WARNING

The remote stethoscope antenna is a useful tool to help identify cables. However, it should not be used as positive identification before an unused cable is cut. Always follow company procedures when cutting disused or isolated cables.



TIP

The remote antenna USB stethoscope can be used to help identify disused and isolated cables. This process can be further enhanced if the cable is isolated and is of a twisted cable construction.

Enhanced loopback method of cable identification

Method:

- Connect the transmitter to two of the cores of the cable. At the far end short together these two conductors making a loop.
- Set the transmitter to a low frequency such as 640Hz and set the output to maximum.

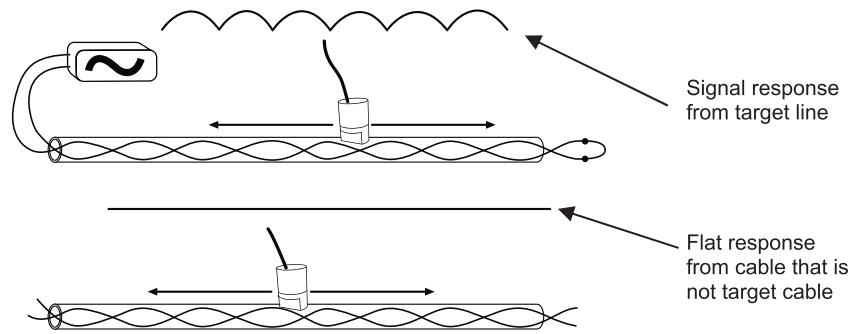

3. At the point of interest, run the remote stethoscope antenna along the suspected target cable. If the correct cable is being assessed the signal will increase and decrease in sympathy with the twist of the two conductors within the cable.
4. If the signal is a steady level and does not rise and fall, this is probably not the target cable.



WARNING

The remote stethoscope antenna is a useful tool to help identify cables. However, it should not be used as positive identification before an unused cable is cut. Always follow company procedures when cutting disused or isolated cables.

Using the SD Signal with the Remote Antenna to help identify a cable



NOTE

This technique requires the use of the latest analogue stethoscope which was introduced late in 2015 and can be identified by the arrow marking labels on the antenna head.



Method:

1. Apply the signal using the direct connection method. Remember to isolate the cable beforehand as below. It is also preferable to use the ground stake as an independent ground. Using the station ground may result in multiple signals as the signal will return along commonly bonded cables.

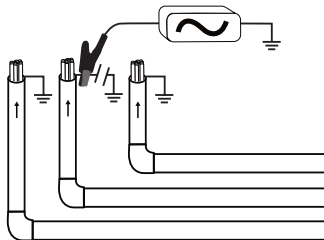

2. Select an SD signal from the transmitter (either SD-USA or SD-EUR).
3. Connect the remote antenna accessory to the locator and place it on the red lead of the transmitter with the arrow pointing away from the transmitter. Select the frequency using the “f” button so that it matches the selection on the transmitter. The screen should look similar to the below picture.

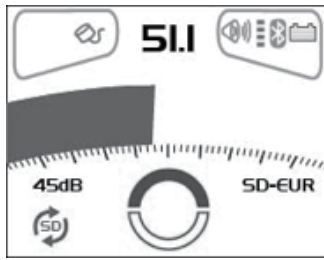

4. If necessary adjust the sensitivity so that the bar graph is on scale. Note that the front half of the circle is red. This indicates that the signal is flowing forwards. If the bottom half is illuminated as below, it will be necessary to perform an SD reset before proceeding. However, if in doubt always perform the reset to be sure the antenna and receiver are synchronized.

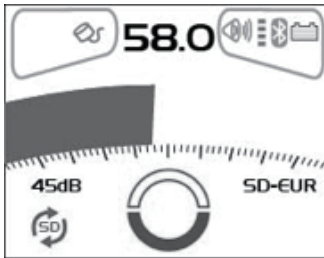

Perform a remote antenna SD reset

Always connecting the transmitter to the service to be identified, place the antenna on the red cable as previously described. Press the "i" button. The screen will change to something similar to the below.



Press the "M" button as indicated by the hand. The screen will then revert to the one below with the front half of the circle red. This indicates that the reset was successful.

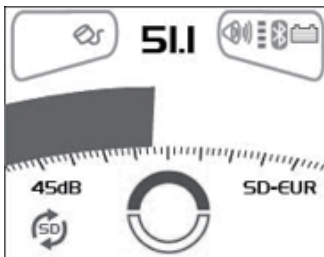

The system is now ready to identify the cable at the location of the interest.

Identifying a cable

Having confirmed the antenna is synchronized with the receiver, proceed to the location the cable is to be identified. Place the antenna on each of the suspected cable in turn ensuring the correct orientation, ie the arrow on the antenna pointing away from the transmitter.



Note the signal strength on each cable and also which half of the circle is illuminated. The target cable will have the strongest signal and will have the front portion of the circle illuminated red.

Enhancing the loopback method of cable identification with the aid of the SD signal

As described before, a more reliable method of loop backing the signal on the cable is possible if the cable is out of service. This method can be further enhanced with the aid of the SD signal.

Method:

Set up the transmitter as below, with the far end connected together and with the transmitter connected across a twisted pair of cable. Set the transmitter to SD EUR or SD USA and perform an SD reset as described above.

At the location of interest, hold the antenna on each of the cables in turn. Run the antenna along the cable keeping the arrow on the antenna pointing forwards. On the incorrect cable the signal level will be small and steady. On the correct target cable the signal will rise and fall in sympathy with the twist in the cable. Also, if on the target cable, at alternate peaks the red portion of the circle will switch from forward to backward pointing.

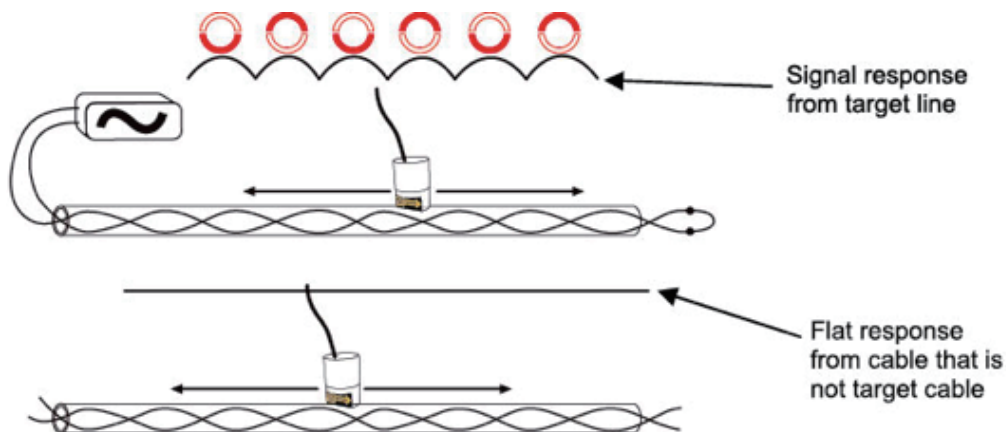

WARNING

The remote stethoscope antenna is a useful tool to help identify cables. However, it should not be used as positive identification before an unused cable is cut. Always follow company procedures when cutting disused or isolated cables.

10. Accessories & Options

10.1 A-frame (Optional)



The A-frame accessory is used to detect ground faults on pipes and cables. In the case of pipes, the faults consist of coating defects. In the case of cables, faults are usually caused by insulation damage allowing the metallic sheath (or internal conductor) to become in contact with the ground.

10.2 Remote Antenna (Optional)



The remote antenna can be used to help identify a particular cable on a cable tray or where cables are bunched together.

10.3 Loc-10Tx Vehicle Power Lead (Optional)

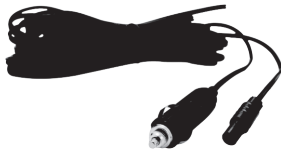

12V DC, 30ft (10m) lead to power the transmitter from a vehicle.

Note, this is **not** a charge lead.

If it is intended to apply the transmitter to a target line at high output levels and long periods, it may be useful to power the transmitter using the 12V DC vehicle power lead. To power the transmitter from the 12V DC vehicle power lead, connect the lead to the 12V DC input socket positioned on the side of the transmitter. Plug the cigarette lighter plug into the vehicle cigarette lighter socket (be sure that the socket is live. Some vehicles only activate the cigarette lighter when the vehicle is running).

It is not necessary to disconnect or remove the standard batteries as the unit will automatically select the external 12V DC supply.

10.4 Loc-10Tx Outdoor Power Supply (Optional)



12V DC, 30ft (10m) lead to power (not charge lead) the transmitter from the mains supply.

Note, this is not a charging lead.

10.5 LPC Separation Filter (Optional)



The LPC separation filter (LPC) is used to safely inject a trace tone to a live cable via a domestic mains socket, so that the cable can be traced from the premises to the connection in the street. It is suitable for connecting to voltages between 100V AC and 250V AC.

10.6 Receiver Vehicle Charging Lead (Optional)



12ft (4m) long lead to charge the receiver's battery (Lithium-ion) while on the move.

It is preferable to connect the charger to a cigarette lighter socket that is permanently live. However, **do not** leave connected to the receiver for excessively long periods.

10.7 Sonde (Optional)



D18-33-SR44 Sonde

- 0.7in (18mm) x 3.2in (81mm) long, 33 kHz, range 15ft (4.5m).
- 2 x button cell batteries.



D38-33-AA Sonde

- 1.5in (38mm) x 4.1in (105mm) long, 33 kHz, range 16.3ft (5m).
- 1 x AA battery.



D38-09-AA Sonde

- 1.5in (38mm) x 4.1in (105mm) long, 9.8 kHz, range 16.3ft (5m).
- 1 x AA battery.



D38-83-AA Sonde

- 1.5in (38mm) x 4.1in (105mm) long, 83 kHz, range 16.3ft (5m).
- 1 x AA battery.



D64-33-LR61 Sonde

- 2.5in (64mm) x 7.3in (186mm) long, 33 kHz, range 26ft (8m).
- 1 x LR61 battery.



D64-09-LR61 Sonde

- 2.5in (64mm) x 7.3in (186mm) long, 9.8 kHz, range 26ft (8m).
- 1 x LR61 battery.



D64-83-LR61 Sonde

- 2.5in (64mm) x 7.3in (186mm) long, 83 kHz, range 26ft (8m).
- 1 x LR61 battery.



D23F-512-AA / D23F-640-AA Sonde

- 1in (23mm) x 18in (456mm) long, range 20ft (7m).
- "Flexible (3 section) Sonde with optional 512Hz or 640Hz for use in cast iron pipes".
- 1 x AA battery.

10.8 Clamp (Optional)



- VX2/50, VX4/100, VX5/125, VX18/450F
- Dia. 2in (50mm), Dia. 4in (100mm), Dia. 5in (125mm), 18in flexible (Circumference 450mm)

An accessory used to apply the transmitter signal to an insulated line, removing the need to connect the transmitter signal directly to a conductor or cable sheath.

10.9 Clamp Extension Rod



The extension rod is fitted with a 10mm screw thread. This male thread will screw into the handle of the signal clamp and will enable the clamp to be attached too hard to reach cables such as in manholes or overhead cables.

The extension rod is also fitted with a female thread in the handle which enables the rods to be fitted together to further extend the range. To access this thread the yellow handgrip needs to be slid off the end of the rod.

To operate the clamp jaws when attached to the rod, gently pull on the clamp cord which will open the jaws. Release to cable to close them.

10.10 Lithium-ion Rechargeable Battery Pack (Standard)



The Lithium-ion rechargeable battery pack is supplied as standard. Use the battery charger listed below to charge the battery pack. Charging is done with the battery inside the receiver.

10.11 Receiver Battery Charger (Standard)



The receiver Lithium-ion battery charger is supplied as a standard item. It is powered from the mains supply (100-250V AC)

10.12 USB Cable (Standard)



The USB cable is used to connect the receiver to a host computer so that software updates can be implemented and also for the transfer of data logs from the unit to a computer.

10.13 Alkaline Battery Holder (Standard)

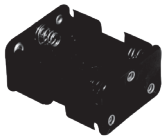

This battery pack is supplies as standard and is used in the event the rechargeable battery pack has fully discharged. It can be considered as a backup battery pack. It requires 6 x AA alkaline batteries.

10.14 Ground Stake (Standard)



Used to make an independent connection to the ground so as to complete the circuit when the transmitter is connected to a line using the direct connection method.

10.15 Direct Connection Lead (Standard)



Used to connect the transmitter to a line using the direct connection method.

10.16 Loc-1Tx Alkaline Battery Tray (Standard)



Requires 4 x Alkaline D cells.

10.17 Ground Spool (Optional)



Used to extend the ground connection to a suitable grounding position.

10.18 Banana Plugs Adapter (Optional)



Adapts the direct connection crocodile clip to banana plug allowing the direct connection leads to be connected to a banana socket.

10.19 Loc-5STx Battery Pack (NiMH)



NiMH rechargeable battery pack. Only use the charger supplied as below.

10.20 Loc-5STx Alkaline Battery Tray



Requires 8 x Alkaline D cells.

10.21 Loc-5STx/10Tx Charger



Mains charger (100-250V AC input) used to charge 5 Watt or 10 Watt rechargeable battery packs. Supplied as standard with rechargeable battery option.

10.22 Loc-10Tx Rechargeable Battery Tray



NiMH rechargeable battery pack. Only use the charger supplied.

10.23 Loc-10Tx Alkaline Battery Tray





Requires 12 x Alkaline D cells.

10.24 Live Cable Connector (LCC)



For use on live cables up to 480V AC 60/50Hz. Operating frequencies: 8.192k Hz, 32.768k Hz, 8.44k Hz SIS. For best results, connect across a phase cable and independent ground.

11. Glossary

Active Locate	A locate where a transmitter is used to apply a signal to a buried pipe or cable, the position of which is then located by a receiver tuned to the same frequency.
Active Signal	A signal applied by the locator transmitter to a buried line. Typical this is a very precise frequency.
Attenuation	The reduction of an electromagnetic signal from a pipe or cable.
Clamp (or Coupler)	An accessory used to apply the transmitter signal to an insulated line, removing the need to connect the transmitter signal directly to a conductor or cable sheath.
Compass	Line direction indicator (although visually like a compass, this is the only relation to a compass.)
Coupling	The act of signals transferring to lines to which they were not originally applied. Coupling can be "direct" where the target line has an electrical connection to another line, or "induced" where the signal radiates from the target line to another line or lines.
Display	The information visually available on the dot matrix display.
Line	A generic term for any buried pipe or cable.
Null	A minimum response to a buried line. 
Passive Locate	A locate where the receiver searches for a wide range of signals that radiate from buried pipes or cables. These signals come from a variety of sources in the environment and couple to the buried (& overhead) lines. Typical examples 50 / 60Hz and LF/VLF radio.
Passive signals	A wide range of signals that radiate from buried pipes or cables. These signals come from a variety of sources in the environment and couple to the buried (& overhead) lines. Typical examples 50/60Hz and LF/VLF radio.
Peak	A maximum response to a buried line. 
Pinpoint	Using a receiver to identify the exact position of a buried line.
Response	The indication that the receiver gives, which is caused by the signals it is receiving. This can be visual, audio or both. Typically, it is displayed on the locators dot matrix display and audibly from a loudspeaker in the receiver housing.
Search (sweep)	This describes the act of looking for a buried line within a given area.
Sonde	A small transmitting coil which may be built into a product such as a sewer camera or packaged as a small self-contained battery powered transmitter. A receiver tuned to the same frequency can locate the position of the Sonde and hence whatever it is attached to or in. Frequently used for locating sewer cameras, and the nonmetallic pipes.
Target Line	The buried pipe or cable to be located.
Trace	Using a locator to follow the path of a buried line.

Illustrations used in the preparation of this manual will inevitably show some resemblance to similar illustrations from other Manufacturers-some manufacturers have given permission for the use of their graphics (Vivax-Metrotech & Seba) is given credit for these use. This statement is intended to attribute such credit.

Disclaimer: Product and accessory specification and availability information is subject to change without prior notice.



